

| | |
|-----------|------------------------------|
| FR | CONSIGNES DE SÉCURITÉ |
| NL | VEILIGHEIDSADVIEZEN |
| DE | SICHERHEITSHINWEISE |
| EN | SAFETY INSTRUCTIONS |
| IT | NORME DI SICUREZZA |
| ES | NORMAS DE SEGURIDAD |
| PT | INSTRUÇÕES DE SEGURANÇA |
| EL | ΟΔΗΓΙΕΣ ΑΣΦΑΛΕΙΑΣ |
| TR | GÜVENLİK TALİMATLARI |
| DA | SIKKERHEDSANVISNINGER |
| SV | SÄKERHETSINSTRUKTIONER |
| NO | SIKKERHETSANVISNINGER |
| FI | TURVAOHJEET |
| HU | BIZTONSÁGI ELŐÍRÁSOK |
| SR | SIGURNOSNA UPUTSTVA |
| BS | SIGURNOSNE UPUTE |
| BG | ИНСТРУКЦИИ ЗА БЕЗОПАСНОСТ |
| SL | VARNOSTNA NAVODILA |
| PL | INSTRUKCJA BEZPIECZEŃSTWA |
| CS | BEZPEČNOSTNÍ POKYNY |
| SK | BEZPEČNOSTNÉ POKYNY |
| HR | VAŽNE PREPORUKE |
| RU | ИНСТРУКЦИЯ ПО БЕЗОПАСНОСТИ |
| UK | ІНСТРУКЦІЇ З ТЕХНІКИ БЕЗПЕКИ |
| RO | PRECAUȚII IMPORTANTE |
| ET | OHUTUSJUHISED |
| LV | DROŠĪBAS NORĀDES |
| LT | SAUGOS INFORMACIJA |
| AR | عربي |
| FA | فارسی |

INSTRUCȚIUNI DE SIGURANȚĂ PRECAUȚII IMPORTANTE

Citiți și respectați instrucțiunile de utilizare. Păstrați-le într-un loc sigur.

- Acest aparat poate fi utilizat de copiii în vârstă de cel puțin 8 ani dacă au beneficiat de supraveghere sau au primit instrucțiuni cu privire la utilizarea în siguranță a aparatului și dacă înțeleg pericolele implicate. Curățarea și întreținerea realizate de utilizator nu trebuie efectuate de copii, decât dacă sunt în vârstă de cel puțin 8 ani și sunt supravegheați. Nu lăsați aparatul și cablul de alimentare al acestuia la îndemâna copiilor cu vârste mai mici de 8 ani.
- Aparatul poate fi utilizat de persoane cu capacități fizice, senzoriale sau mentale reduse sau care sunt lipsite de experiență sau nu posedă cunoștințele necesare dacă au beneficiat de supraveghere sau au primit instrucțiuni cu privire la utilizarea în siguranță a aparatului și înțeleg pericolele.
- Copiilor nu le este permis să se joace cu aparatul.
- Acest aparat nu este conceput pentru a fi utilizat de persoane (inclusiv copii) cu capacități mentale, senzoriale sau fizice reduse, sau lipsite de experiență sau cunoștințe, dacă nu au primit instrucțiuni referitoare la modul de utilizare a aparatului sau nu sunt supravegheate de o persoană responsabilă pentru siguranța lor.
- Copiii trebuie supravegheați pentru a vă asigura că

nu se joacă cu aparatul.

- Aparatul este proiectat exclusiv pentru uz domestic.
- Aparatul nu este proiectat pentru a fi utilizat în cadrul următoarelor aplicații, pentru care nu se aplică condițiile de garanție:
 - bucătăria dedicată angajaților din cadrul unor magazine, birouri sau alte medii de tip rezidențial;
 - ferme
 - clienți în cadrul hotelurilor, motelurilor sau alte medii de tip rezidențial
 - medii de tip „B & B” (cazare și mic dejun)
- În cazul în care cablul de alimentare este deteriorat, acesta trebuie înlocuit de producător, de serviciul postvânzare al acestuia sau de persoane cu o calificare similară pentru evitarea oricărui pericol.
- Aparatul nu trebuie imersat.
- Utilizați o lavetă umedă sau un burete și detergent lichid de vase pentru a curăța accesoriile și piesele care intră în contact cu alimentele. Clătiți cu o lavetă umedă sau cu un burete. Ștergeți cu o lavetă uscată accesoriile și piesele care intră în contact cu alimentele.
- Dacă simbolul  este marcat pe aparat, acesta înseamnă „Atenție: suprafețele pot deveni fierbinți în timpul utilizării.”
- Atenție: suprafața elementului de încălzire prezintă căldură reziduală după utilizare.
- Atenție: pericol de accidentare din cauza utilizării

necorespunzătoare a aparatului.

- Întotdeauna, deconectați aparatul de la priză:
 - imediat după utilizare
 - când îl mutați
 - înainte de efectuarea operațiunilor de curățare sau întreținere
- Contactul cu suprafețele fierbinți ale aparatului, cu apa fierbinte, cu aburul sau cu alimentele poate cauza arsuri.
- Nu atingeți aparatul în momentul producerii de abur și utilizați mănuși de protecție pentru a ridica capacul și a scoate bolurile pentru gătit la aburi.
- Pentru orice probleme sau întrebări, vă rugăm să contactați echipa de Relații cu clienții sau să accesați site-ul nostru web.
- Aparatul poate fi utilizat la o altitudine de până la 4 000 m.

- Pentru siguranța dvs., acest aparat respectă toate regulamentele de siguranță și directivele în vigoare la momentul fabricării lui (Directiva referitoare la joasă tensiune, Compatibilitatea electromagnetică, Regulile aplicabile materialelor cu care intră în contact mâncarea, mediul...).
- Verificați dacă alimentarea cu energie electrică corespunde prevederilor inscripționate pe aparat (curent alternativ).
- Având în vedere diferitele standarde aflate în vigoare, dacă aparatul este utilizat într-o țară alta decât țara unde a fost achiziționat, consultați un centru de service autorizat pentru informații.
- Nu așezați aparatul în apropierea unei surse de căldură sau lângă un cuptor, întrucât poate fi grav deteriorat.
- Nu utilizați un cablu de legătură. Dacă totuși acceptați această răspundere, utilizați un cablu de legătură în stare bună, cu priză cu împământare, adecvată puterii aparatului.
- Nu așezați aparatul în apropierea unui perete sau a unui dulap deoarece aburul

- produs poate deteriora componentele.
- Timpul pentru gătit sunt furnizați cu titlu informativ.
 - Nu lăsați cablul să atârne.
 - Întotdeauna conectați aparatul la o priză cu împământare.
 - Utilizați o suprafață de lucru plană, stabilă, termorezistentă, departe de surse de apă.
 - Nu trageți de cablu pentru a scoate aparatul din priză.
Nu deplasați aparatul atunci când conține lichide sau alimente fierbinți.
 - Nu utilizați aparatul dacă:
 - cablul de alimentare al aparatului este deteriorat
 - aparatul a căzut sau are semne vizibile de deteriorare sau nu funcționează în mod corespunzătorÎn aceste cazuri, aparatul trebuie trimis la un centru de service agreat, apropiat de domiciliul dumneavoastră pentru a evita orice pericol. Nu demontați aparatul
 - Nu demontați niciodată dumneavoastră aparatul.
 - În caz de utilizare în mediul profesional, utilizare neadecvată sau nerespectarea instrucțiunilor, producătorul nu își asumă responsabilitatea și nu se aplică garanția.

Protejarea mediului

- Aparatul dvs. a fost proiectat pentru o funcționare îndelungată. Totuși, dacă vă decideți să îl înlocuiți, nu uitați să vă gândiți cum puteți contribui la protejarea mediului.
- Înainte de a arunca aparatul dvs., trebuie să îndepărtați bateria cronometru și să o predați la un centru local de colectare a deșeurilor (conform modelului).
- Centrele de service agreate vor prelua aparatele dumneavoastră uzate pentru a proceda la distrugerea acestora în conformitate cu normele privind protecția mediului.



Protejarea mediului are prioritate!

- ① Aparatul dvs. conține materiale de valoare, care pot fi recuperate sau reciclate.
- ➡ Predați la un centru local de colectare a deșeurilor.



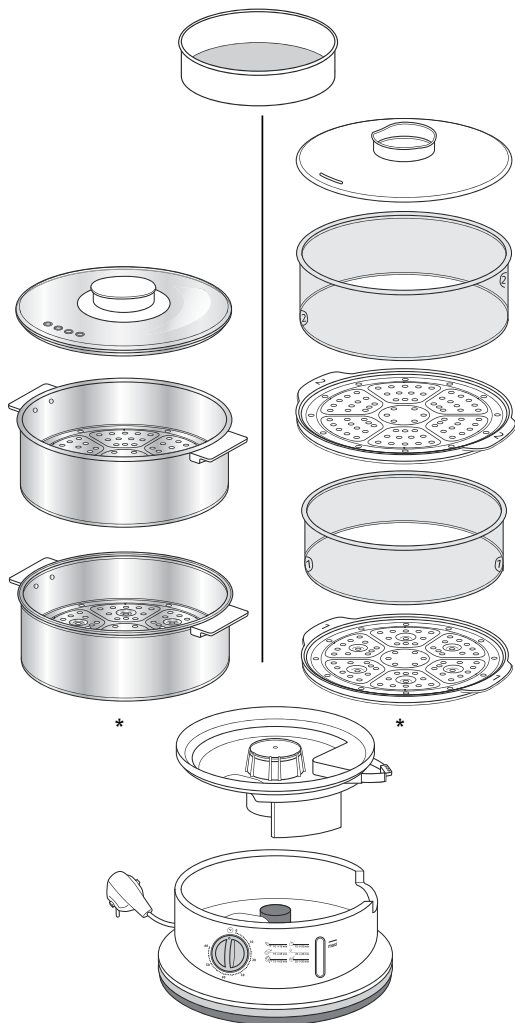

* podle modelu - v závislosti od modelu - modelltöl függően - sõltuvalt mudelist - atkarībā no modeļa - priklausomai nuo modelio - според модела - în funcție de model - u zavisnosti od modela - ovisno o modelu - ovisno o modelu - odvisno od modela - үлгіге байланысты - в зависимости от модели - залежно від моделі - แยกต่างกันในโมเดล - je nach Modell - Secondo il modello

1

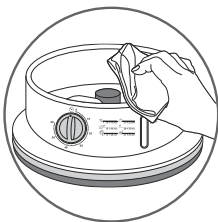
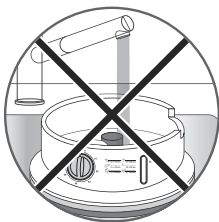
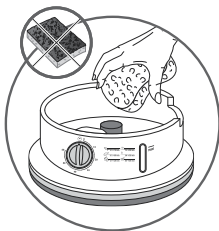
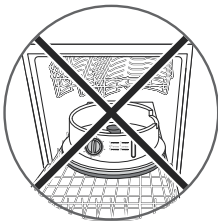
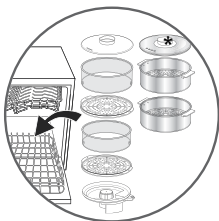
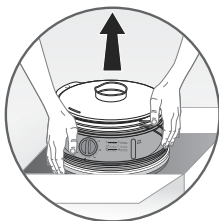
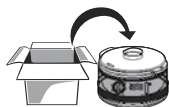

2a

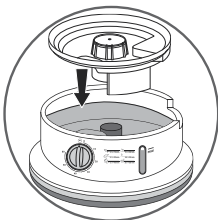
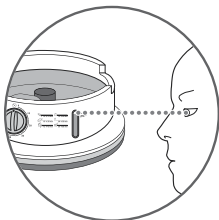
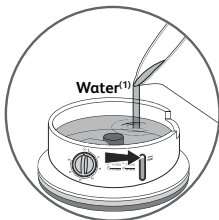

* podle modelu - v závislosti od modelu - modelltöl függően - söltuvalt mudelist - atkarībā no modeļa - priklausomai nuo modelio - според модела - în funcție de model - u zavisnosti od modela - ovisno o modelu - ovisno o modelu - odvisno od modela - үлгіге байланысты - в зависимости от модели - залежно від моделі - ထုတ်အင်္ဂါပုံအရ - je nach Modell - Secondo il modello

⁽¹⁾ Voda - Voda - Víz - Vesi - Üdens - Vanduo - Вода - Apă - Voda - Voda - Voda - Voda - Cy - вода - Вода - น้ำ - Wasser - Acqua

3

2b

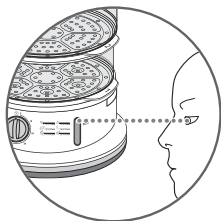
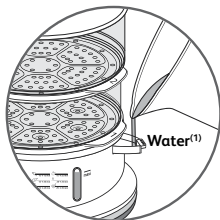
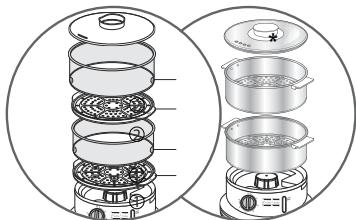
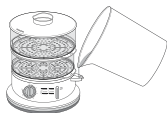

3a

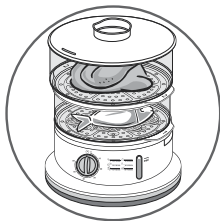
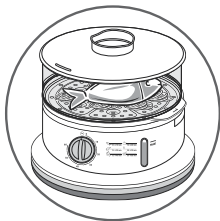
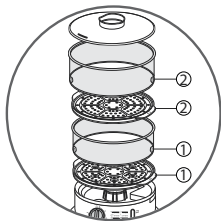

* podle modelu - v závislosti od modelu - modelltöl fúggöen - söltuvalt mudelist - atkaribā no modeļa - priklausomai nuo modelio - според модела - în funcție de model - u zavisnosti od modela - ovisno o modelu - ovisno o modelu - odvisno od modela - үлгіге байланысты - в зависимости от модели - залежно від моделі - ထုတ်ကုန်အမျိုးအစားပေါ် - je nach Modell - Secondo il modello

4

(1) Voda - Voda - Víz - Vesi - Üdens - Vanduo - Вода - Арă - Voda - Voda - Voda - Voda - Cy - вода - Вода - น้ำ - Wasser - Acqua

3a _____

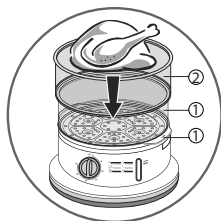

3b _____

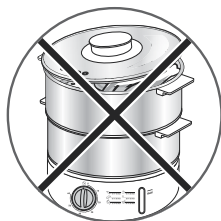
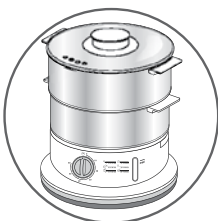
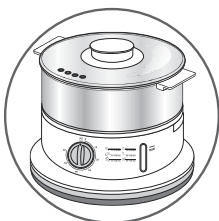
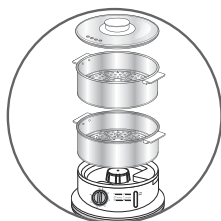
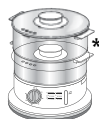

* podle modelu - v závislosti od modelu - modelltöl fúggðen - söltuvalt mudelist - atkaribā no modeļa - priklausomai nuo modelio - според модела - în funcție de model - u zavisnosti od modela - ovisno o modelu - ovisno o modelu - odvisno od modela - үлгіре байланысты - в зависимости от модели - залежно від моделі - แดกต่างกันไปในแต่ละรุ่น - je nach Modell - Secondo il modello

4 _____

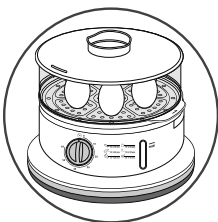
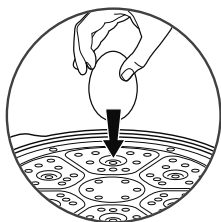
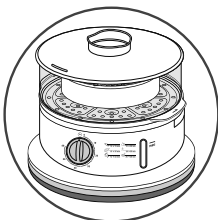
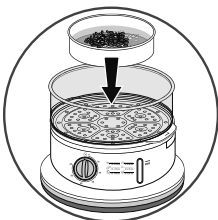
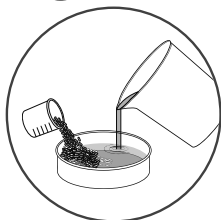

5 _____

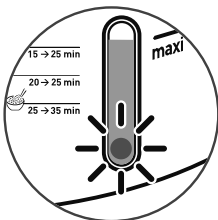
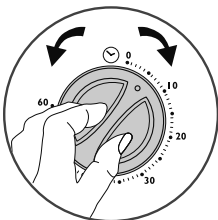
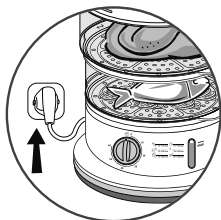

6

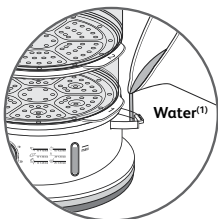
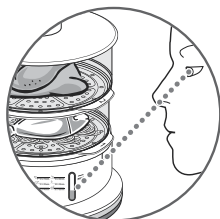
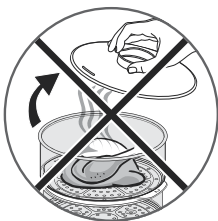
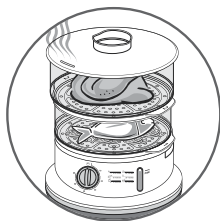
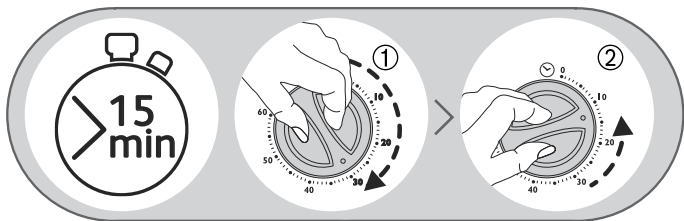

⁽¹⁾ Voda - Voda - Víz - Vesi - Üdens - Vanduo - Вода - Apā - Voda - Voda - Voda - Voda - Cy - вода - Вода - น้ำ - Wasser - Acqua

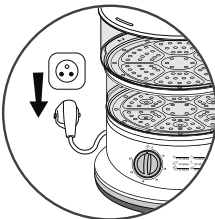
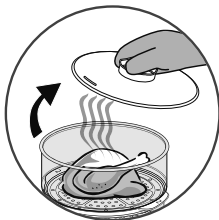
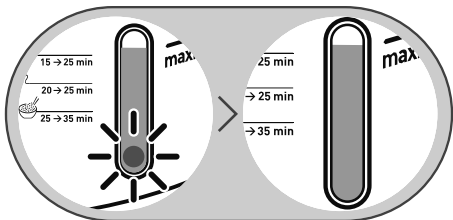
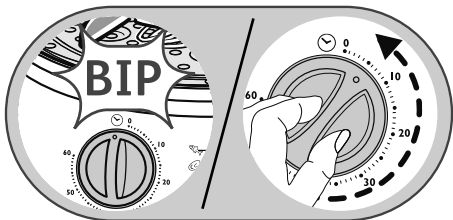

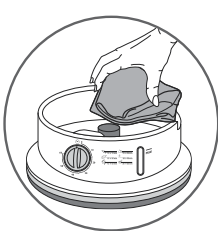
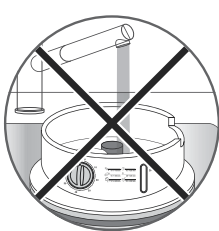
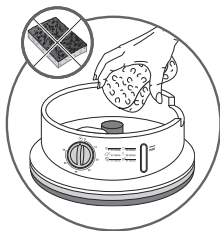
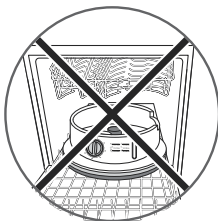
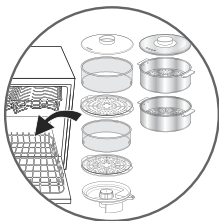
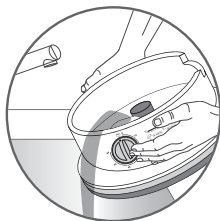
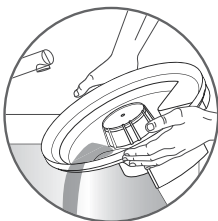
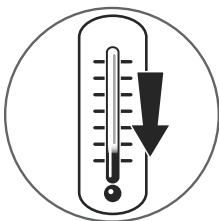
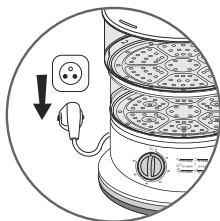

* podle modelu - v závislosti od modelu - modeltöl függően - söltuvalt modelist - atkarībā no modeļa - priklausomai nuo modelio - според модела - în funcție de model - u zavisnosti od modela - ovisno o modelu - ovisno o modelu - odvisno od modela - үлгіре байланысты - в зависимости от модели - залежно від моделі - шлпкпжнлпнлшкпжн - je nach Modell - Secondo il modello

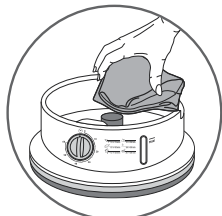
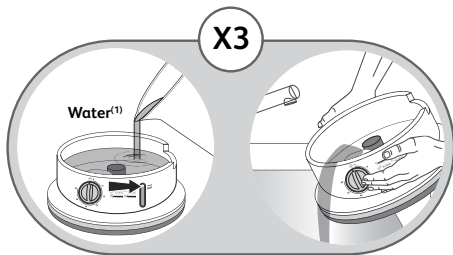
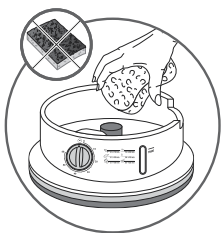
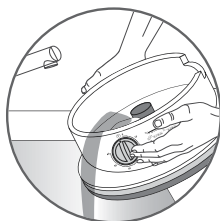
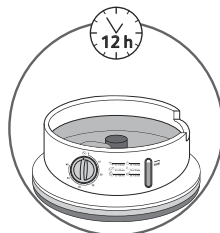
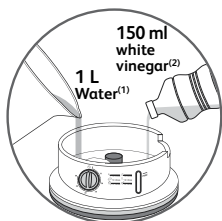
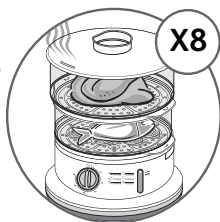





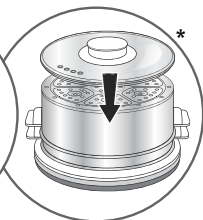
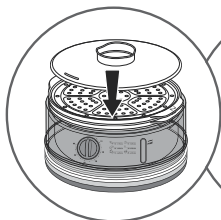
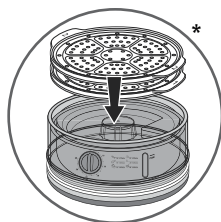
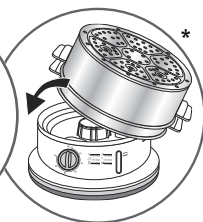
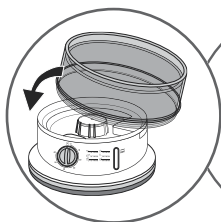
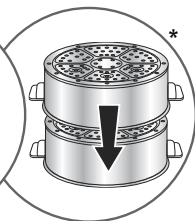
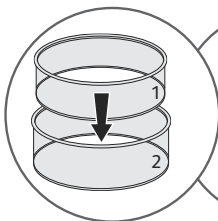
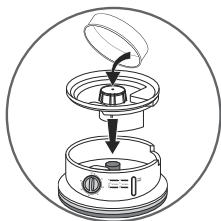
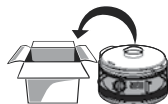





⁽¹⁾ Voda - Voda - Víz - Vesi - Üdens - Vanduo - Вода - Арă - Voda - Voda - Voda - Voda - Су - вода - Вода - 水 - Wasser - Acqua





























































⁽²⁾ Bílý ocet - Biely ocot - Fehérecet - Valge äädikas - Baltais etiķis - Baltasis actas - Бял оцет - Oțet alb - Belo sirće - Bijelo sirće - Bijeli ocat - Alkoholni kis - Ақ сірке су - белый уксус - Білий оцет - น้ำส้มสายชู - weißem Essig - Aceto bianco



* podle modelu - v závislosti od modelu - modelltől függően - söltuvalt mudelist - atkarībā no modeļa - priklausomai nuo modelio - според модела - în funcție de model - u zavisnosti od modela - ovisno o modelu - ovisno o modelu - odvisno od modela - үлгіге байланысты - в зависимости от модели - залежно від моделі - ထုတ်ကုန်အမျိုးအစားပေါ် - je nach Modell - Secondo il modello



| | |  |  (i)  |
|---|---|---|---|
|  | | 550 g | 30-35 min |
|  | | 500 g | 30-35 min |
|  | *** | 400 g | 25-31 min |
|  |  | 300 g | 20-25 min |
|  | | 500 g | 20-25 min |
|  |  | 600 g | 25-30 min |
|  |  | | 30-35 min |
|  | | 300 g | 15-20 min |
|  | *** | 300 g | 15-20 min |
|  | | 450 g | 35-40 min |
|  | *** | 400 g | 30-35 min |

| | | | | |
|---|---|---|-------|---|
|  |  |  | 300 g |   (i)  |
| |  |  | 300 g |   (i)  |
| |  | | 600 g |   (i)  |
| |  | | 600 g |   (i)  |
|  |  | | 4 |   (i)  |
| |  | | 4 |   (i)  |
|  |  | | 350 g |   (i)  |
| |  |  | 400 g |   (i)  |
| |  | | 300 g |   (i)  |
|  |  | | 450 g |   (i)  |
| |  | | 4 |   (i)  |
|  | | | 6 |   (i)  |
|  |  | 200 mL Water ⁽¹⁾ | 125 g |   (i)  |

⁽¹⁾ Voda - Voda - Víz - Vesi - Üdens - Vanduo - Вода - Apă - Voda - Voda - Voda - Voda - Cy - вода - Вода - 水 - Wasser - Acqua

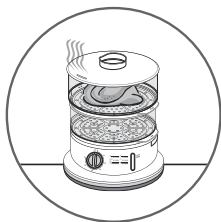
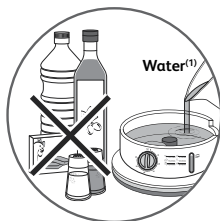
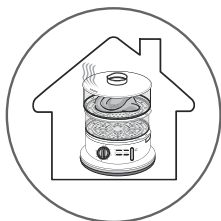

⁽¹⁾ Voda - Voda - Víz - Vesi - Üdens - Vanduo - Вода - Apã - Voda - Voda - Voda - Voda - Cy - вода - Вода - น้ำ - Wasser - Acqua

