

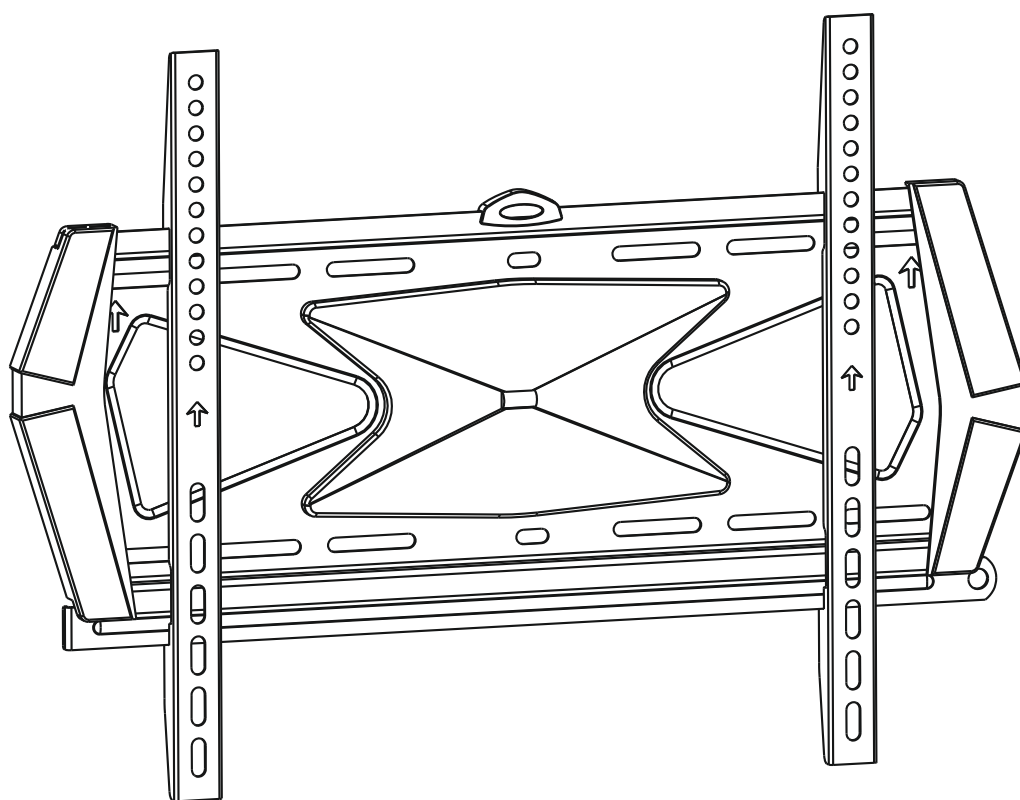

UCH0140

Suport de perete fix



Manual de utilizare



300x300/400x200
400x400



English 1-10

Polski 11-20

Română 21-30

Deutsch 31-40

Inainte de instalare



- Nu incepeti instalarea suportului decat dupa ce ati citit si inteles instructiunile de montare.
- Respectati recomandarile din acest manual de instalare cu privire la distanta fata de perete necesara la montarea suportului.
- Instalarea suportului este recomandata sa fie executata de catre personal calificat.
- Verificati daca peretele este poate suporta sarcinile maxime admisibile de catre suport.
- Nu depasiti sarcina maxima admisibila a suportului.
- Asigurati-va ca suruburile de fixare pentru diblu sa fie centrate exact in mijlocul gaurilor de pozitionare de pe suport (eventual utilizati un dispozitiv de centrare) in momentul strangerii acestora.
- Strangeti suruburile ferm dar nu exagerati. Strangerea prea puternica a acestora poate distruge partile componente ale suportului
- Solicitati ajutorul altei persoane pentru pozitionarea aparatului pe suport.
- Suportul este destinat utilizarii in interior. Nu utilizati suportul in exterior pentru a evita riscul producyerii de accidente sau defectarea produsului.

Continut colet

Asigurati-va ca ati primit toate componentele necesare montarii suportului inainte de instalarea acestuia, urmarind figurile urmatoare:

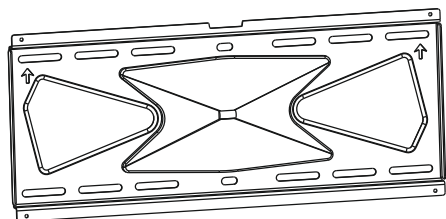

placa de baza (x1)
A



tija de siguranta (x1)
B

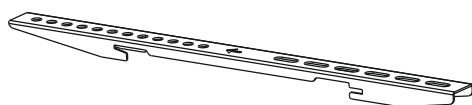

adaptor (x2)
C



nivela cu bula de aer (x1)
D

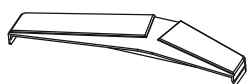

capac decorativ (x2)
E



ST2.9*6.5(x4)
F

Pachet M

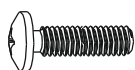

M5x14 (x4)
M-A

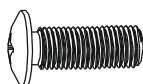

M6x14 (x4)
M-B



M8x20 (x4)
M-C



M6x30 (x4)
M-D

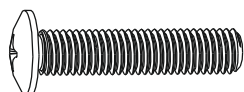

M8x30 (x4)
M-E

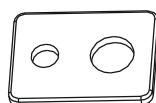

saiba (x4)
M-F



Saiba mica (x8)
M-G



Saiba mare (x4)
M-H

Pachet W

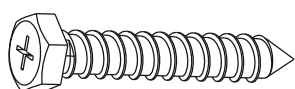

Surub ancorare ST6.3x55 (x4)
W-A

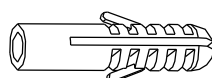

diblu beton (x4)
W-B

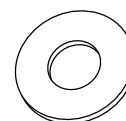

D6 saiba (x4)
W-C

1. Instalarea capacelor decorative

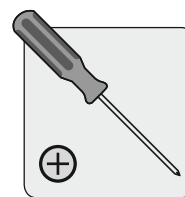
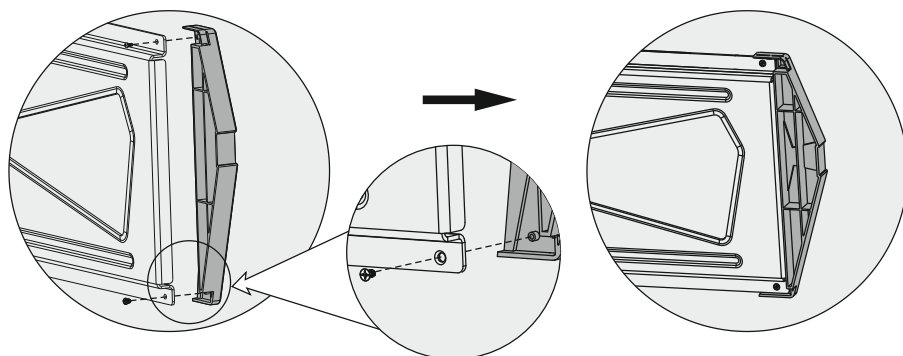

Fixati capacele decorative pe perete cu ajutorul suruburilor.
Nota: Gaurile capacelor decorative trebuie sa fie orientate in jos!

2a. Montarea suportului pe perete de lemn

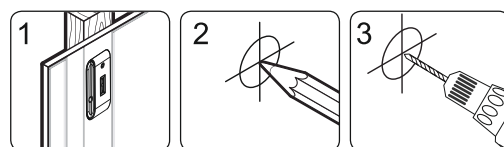
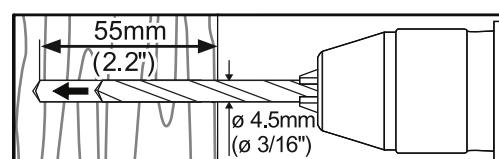
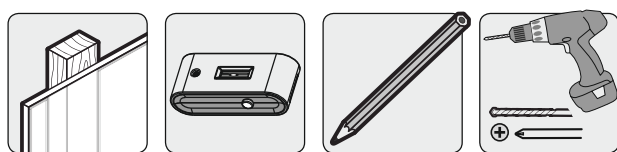

Gasiti si marcati locatia exacta a orificiilor de montare utilizand placa de baza ca sablon. Verificati intai ca aceasta sa fie orizontala, urmarind nivela cu bula de aer. Efectuati gaurile de montare

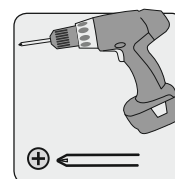
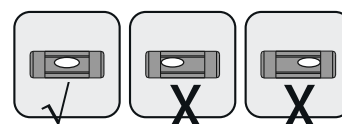
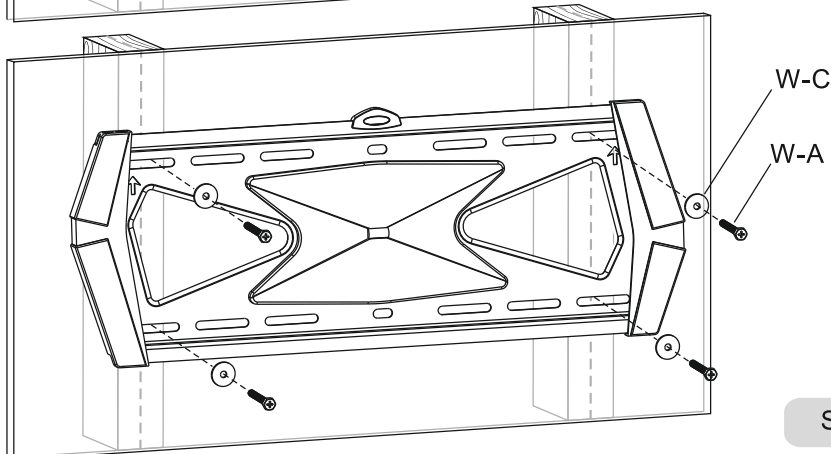
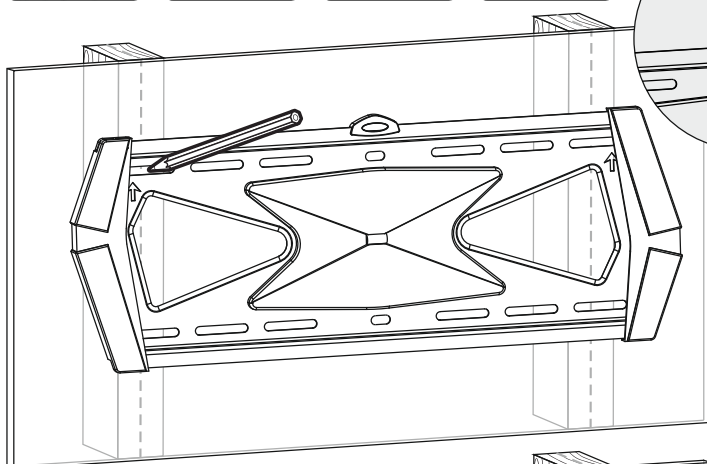

Insurubati placa de baza pe perete

Sageata de pe placa trebuie orientata in sus.

⚠ AVERTISMENT

- Asigurati-va ca suruburile de montare sunt bine pozitionate si stranse. Folosirea unui detector de metale este recomandata atunci cand efectuati gaurile de prindere.
- Cei care instaleaza sunt responsabili cu furnizarea de echipament pentru alte tipuri de situatii de montare.
- Instalatorii trebuie sa verifice ca suprafata de sprijin sa suporte in conditii de siguranta sarcina echipamentelor si toate componentele atasate..

2b. Montarea suportului pe perete de beton

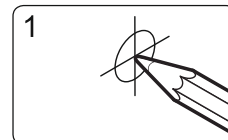
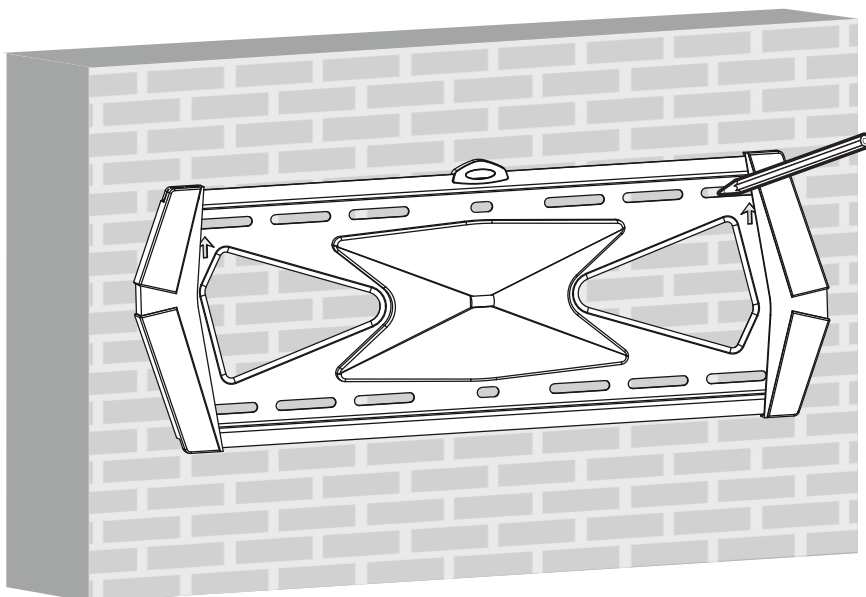
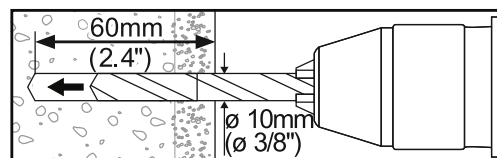
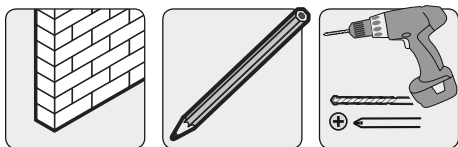

1
Marcati locatia exacta a orificiilor de montare

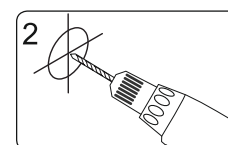

2
Efectuati gaurile de ghidare

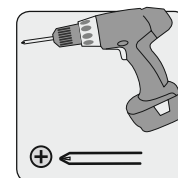
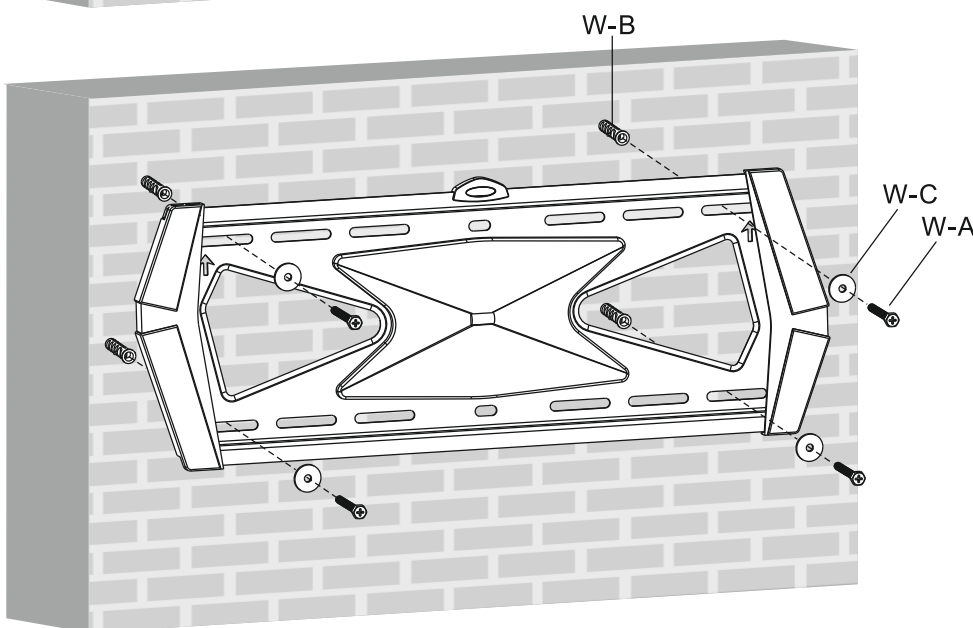
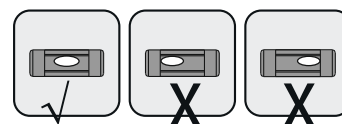

Insurubati placa de baza pe perete

Cu sageata de sus a placii in sus.

AVERTISMENT

- La instalarea suportului pe perete de beton, verificati ca grosimea betonului sa fie de cel putin 1-3/8" (35mm) pentru a putea folosi ancorele de beton. Asigurati-va ca montati pe o suprafata solida, in general lasand o distanta de 1" (25mm) fata de marginea peretelui de beton. Utilizati masina de gaurit cu atentie, pentru a evita spargerea peretelui atunci cand exista un spatiu gol sau o cavitate.
- Instalatorii trebuie sa verifice ca suprafata de sprijin va suporta in conditii de siguranta sarcina echipamentelor si toate componentele atasate.

3. Instalarea adaptoarelor pentru suport

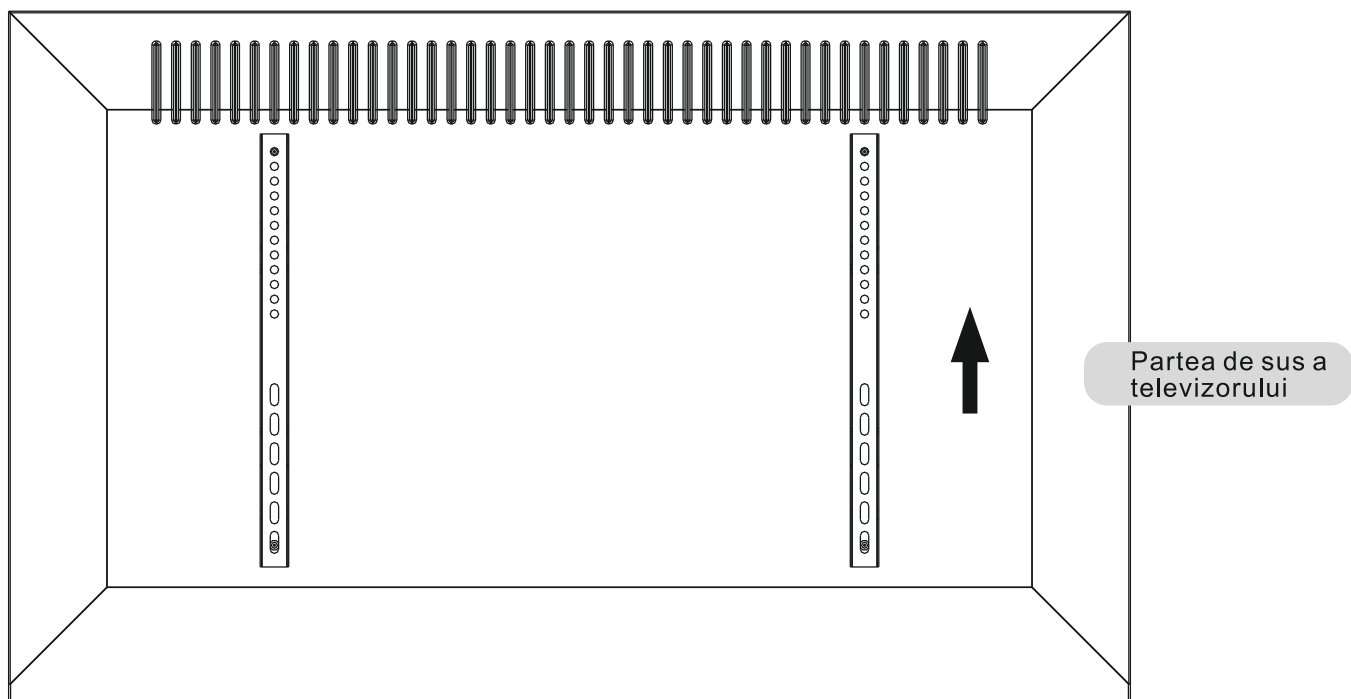

3-1 Pentru TV cu spatele drept (plat)

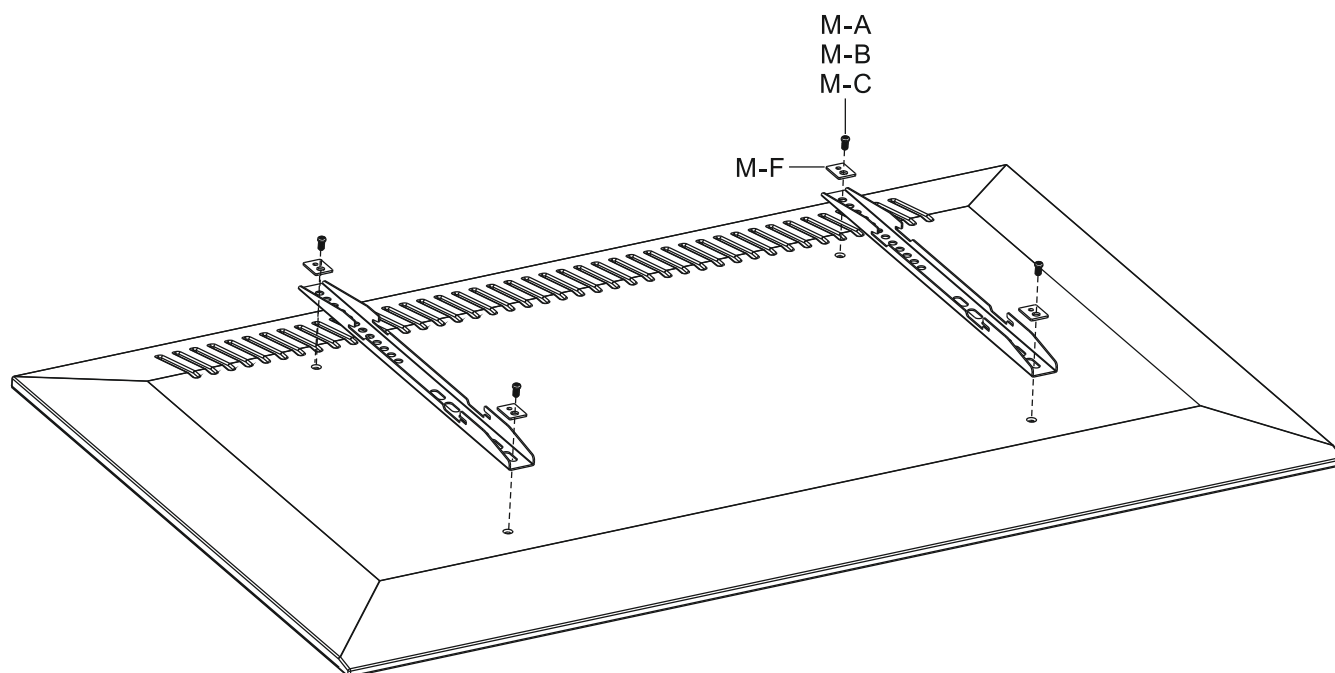
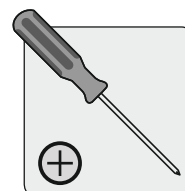
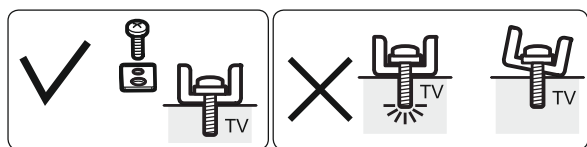

3-2 Pentru TV cu spatele curbat sau pentru accesarea intrarilor A/V

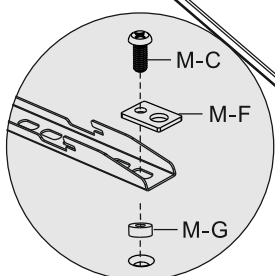
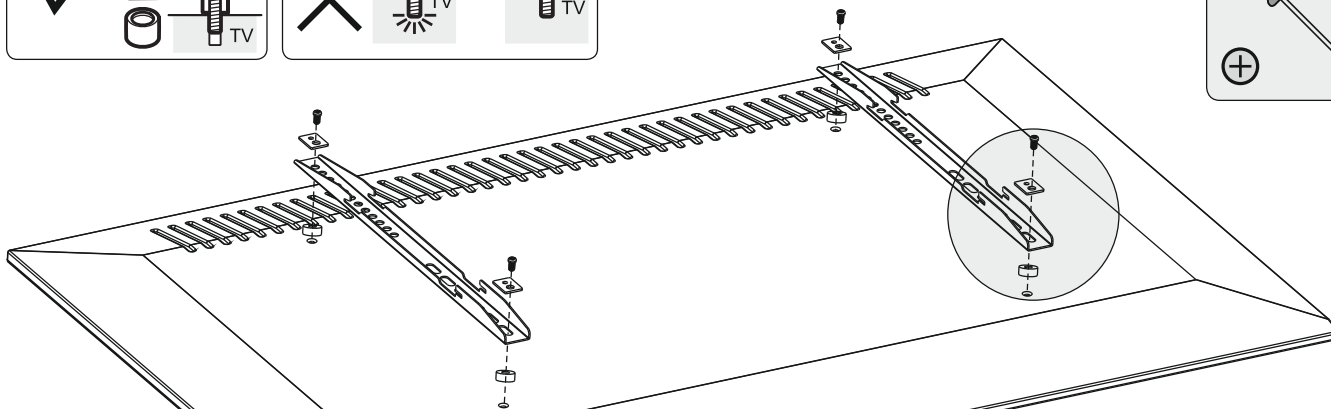
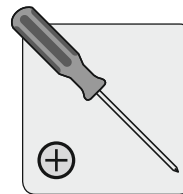
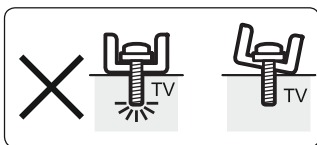
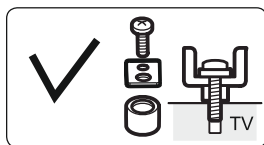

or

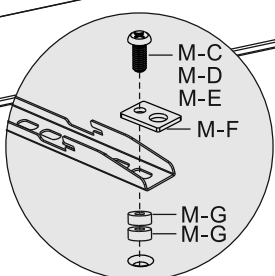

or

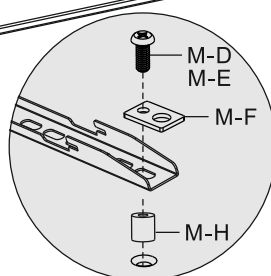

or

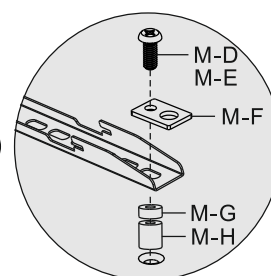

Nota: Alegeti suruburile, saibele si distantierele (daca e necesar) in functie de tipul ecranului.

- Pozitionati adaptoarele cat mai aproape de centrul ecranului.
- Insurubati adaptoarele pe TV.



Strangeti toate suruburile dar nu exagerati.

4. Montarea televizorului pe suport

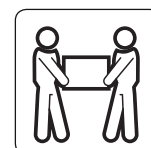
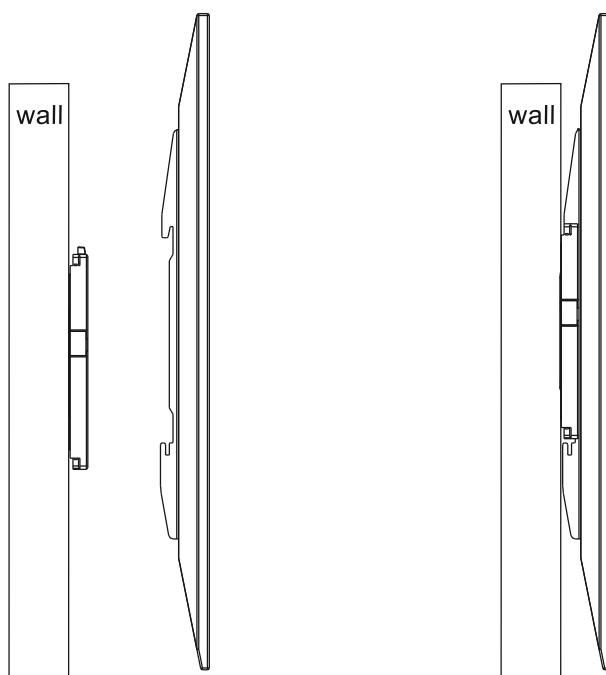

Prindeti televizorul pe partea de sus a placii de perete.

Important: Asigurati-va ca televizorul a fost montat corespunzator inainte de a-i da drumul.

5. Bara de siguranta

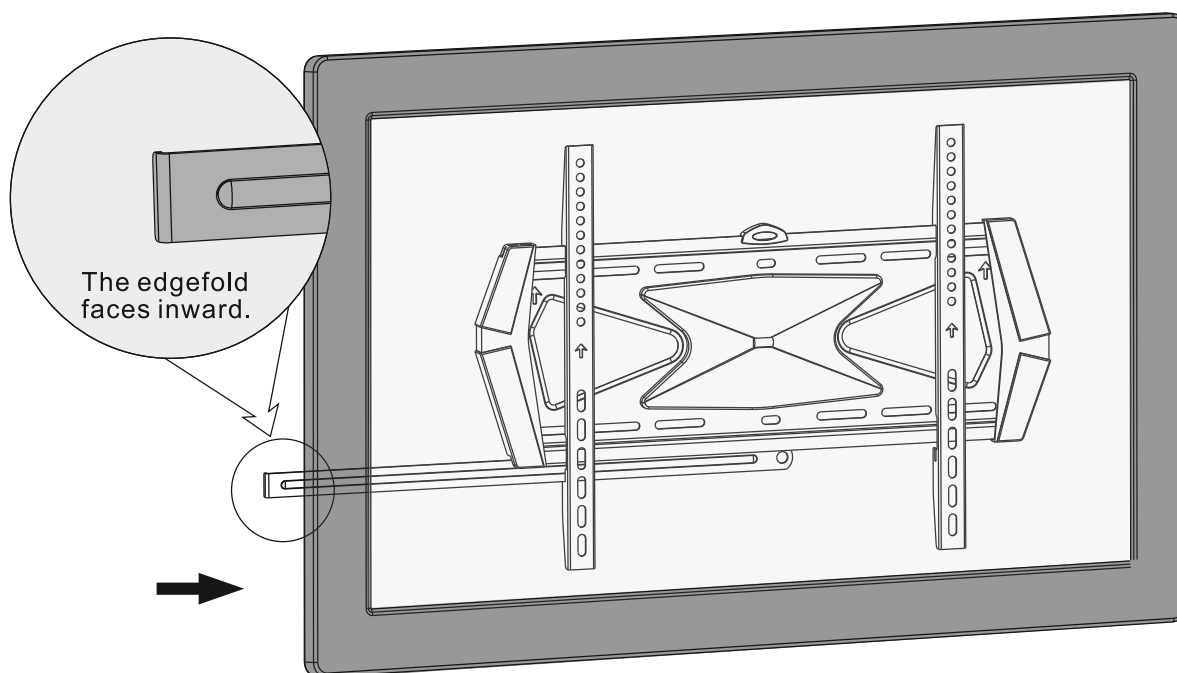

Introduceti bara de siguranta pentru a fixa sinele.

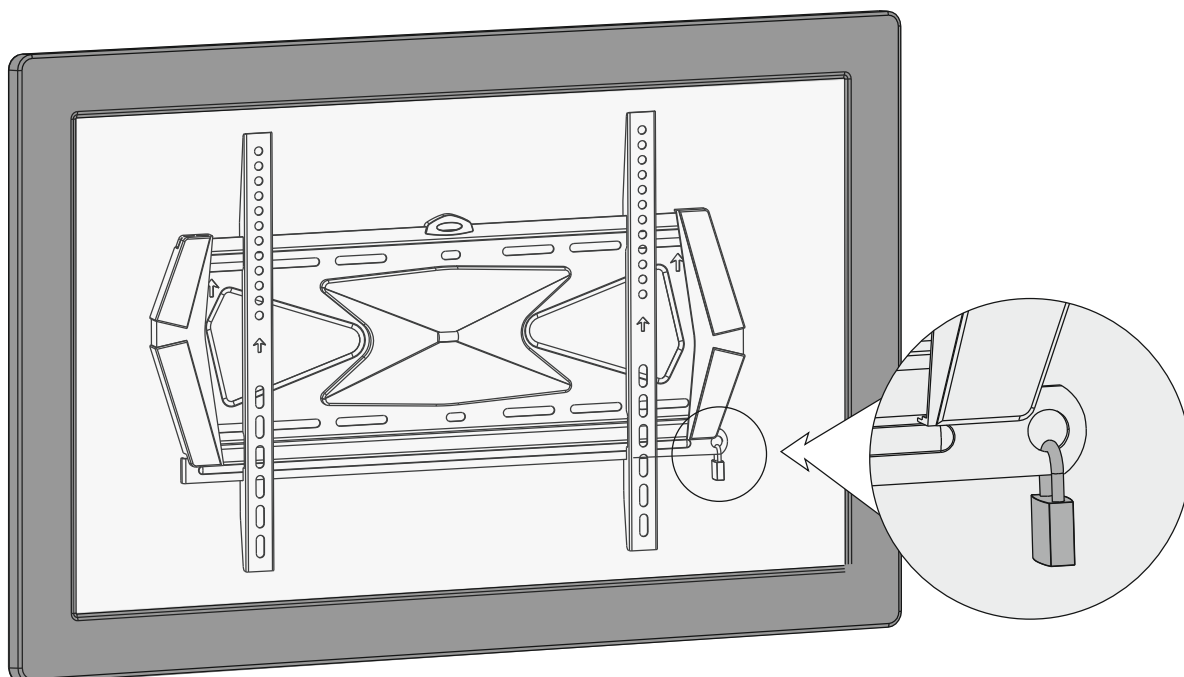

Folositi lacatul pentru a preveni un posibil furt al televizorului. (Lacatul nu este inclus)

Intretinere

Intretinere

- Verificati ca suportul sa fie fixat la intervale regulate (cel putin o data la 3 luni)
- Va rugam sa contactati furnizorul in cazul in care aveti intrebari.

Romania



Reciclarea corecta a acestui produs (reziduuri provenind din aparatura electrica si electronica)

Marcajale de pe acest produs sau mentionate in instructiunile sale de folosire indica faptul ca produsul nu trebuie aruncat impreuna cu alte reziduuri din gospodarie atunci cand nu mai este in stare de functionare. Pentru a preveni posibile efecte daunatoare asupra mediului inconjurator sau a sanatatii oamenilor datorate evacuarii necontrolate a reziduurilor, va rugam sa separati acest produs de alte tipuri de reziduuri si sa-l reciclati in mod responsabil pentru a promova re folosirea resurselor materiale.

Utilizatorii casnici sunt rugati sa ia legatura fie cu distribuitorul de la care au achizitionat acest produs, fie cu autoritatile locale, pentru a primi informatii cu privire la locul si modul in care pot depozita acest produs in vederea reciclarii sale ecologice.

Utilizatori instititionali sunt rugati sa ia legatura cu furnizorul si sa verifice conditiile stipulate in contractul de vanzare. Acest produs nu trebuie amestecat cu alte reziduuri de natura comerciala.

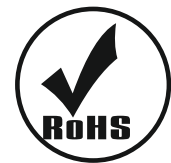

Produs in RPC pentru Lechpol Electronic SRL, Republicii nr. 5, Resita, CS , ROMANIA.