



Dron Falcon - Sparrow by Quer

ZAB0101

ZAB0103

Bedienungsanleitung

DE

Owner's manual

EN

Instrukcja obsługi

PL

Manual de utilizare

RO

Instructiuni privind siguranta

- Cititi cu atentie manualul inainte de utilizarea produsului si pastrati-l pentru consultari ulterioare. Respectati cu strictete instructiunile de utilizare.
- Nu lasati produsul la indemana copiilor.
- Nu lasati produsul nesupravegheat pe durata incarcarii bateriilor.
- Nu aruncati bateriile in foc dupa golirea acestora.
- Nu va apropiati de drona cand elicele sunt in miscare.
- Nu incarcati sa reparati singuri aparatul. In caz de defectare, contactati un service autorizat.
- Opriti aparatul si comanda acestuia in cazul in care nu utilizati aparatul.
- Nu amplasati bateriile langa surse de caldura.
- Pentru siguranta utilizatorilor si a persoanelor, nu manevrati aparatul la o distanta mai mica de 2 m fata de alte persoane sau obstacole.
- Acest aparat nu trebuie utilizat de catre persoane cu abilitati psihice, senzoriale sau mentale reduse, fara experienta sau cunostinte despre utilizarea aparatului, decat daca sunt sub supravegherea unei persoane adulte responsabile cu siguranta lor.
- A nu se utiliza de catre persoane cu varsta sub 14 ani.
- Utilizati doar accesorii originale (inclusiv incarcatorul de acumulatori).
- Nu supraincarcati acumulatorul.
- Distanța de control este diminuata daca drona sau comanda nu sunt complet incarcate.
- Nu atingeti motorul pe durata sau dupa incetarea zborului deoarece acesta se incalzeste si poate fi fierbinte.
- In cazul inlocuirii elicelor aveti grija sa le montati in pozitia corecta.
- Drona este echipata cu protectie la suprasarcina: daca elicele se blocheaza, sistemul de control intrerupe alimentarea rotorului.

Intretinere

1. Curatati dispozitivul cu o carpa curata si uscata.
2. Pastrati drona uscata si feriti-o de medii umede.
3. Nu utilizati drona pe timp de ploaie.
4. Verificati regulat drona si accesorii. Daca gasiti un defect, nu utilizati drona pana cand nu este reparata.

Alimentare

Controller (comanda)

4 baterii 1.5 V 9 nu sunt incluse)

Pentru instalare baterii:

1. Deschideti compartimentul bateriilor.
2. Introduceti 4 baterii de 1.5 V marime AA, respectand polaritatea corecta.

Nota:

- Nu amestecati baterii vechi cu baterii noi.
- Nu amestecati diverite tipuri de baterii.

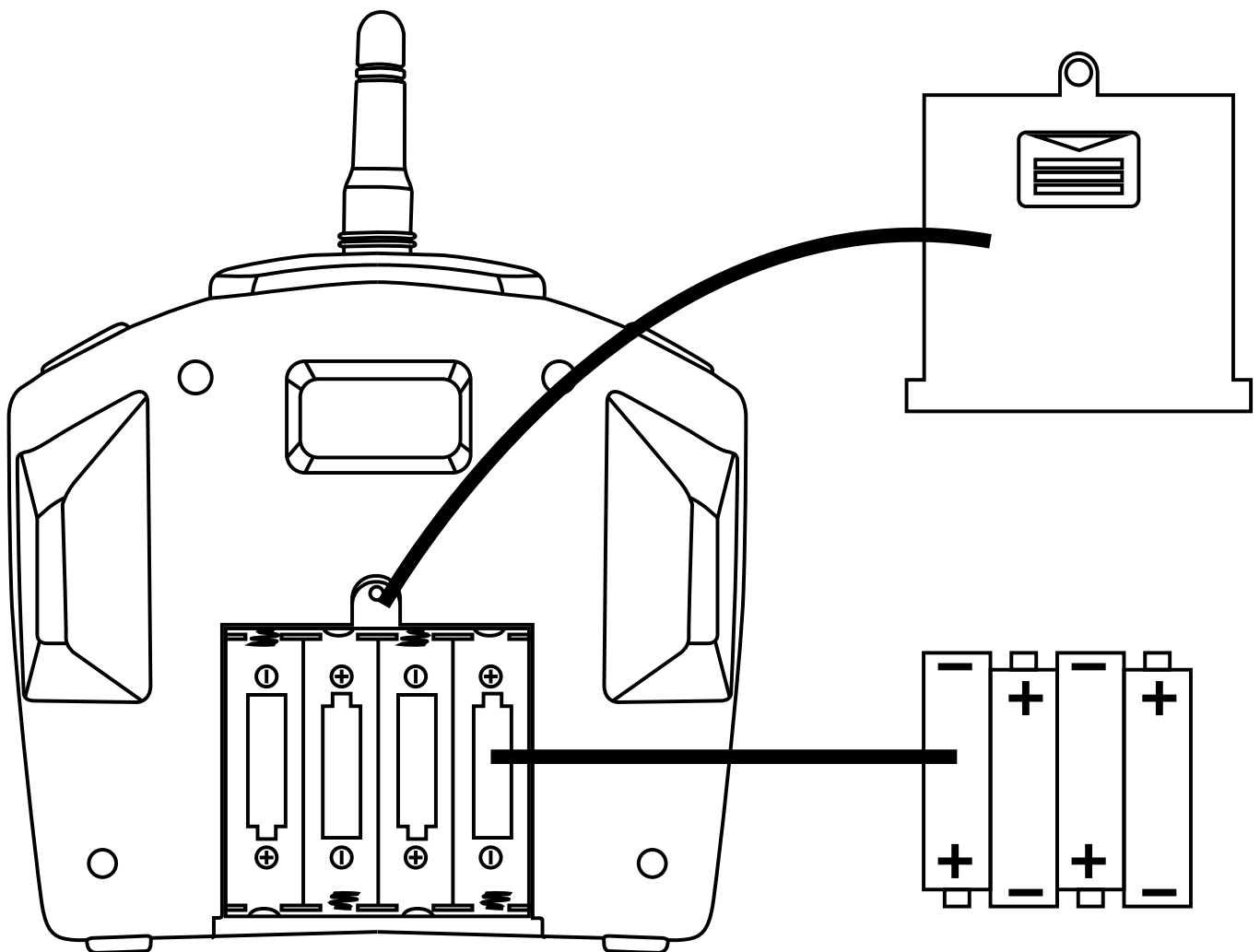

Drona

ZAB0101

Drona este echipata cu baterie reincarcabila Li-Polimer.

Incarcare

1. Demontati bateria din suportul ei.
2. Conectati conectorul rosu de pe baterie la conectorul rosu al cablului USB. Insert the USB connector into the AC wall charger. Then plug the AC wall charger into a power supply socket per the rating specified on the included AC wall charger.
3. Introduceti cablul USB in alimentatorul AC de perete, apoi introduceti alimentatorul in priza de perete. Insert the USB connector into the AC wall charger.
4. Dupa incarcarea bateriei reincarcabile, deconectati-o de la alimentator.
5. Puneti bateria la loc in locasul ei de pe drona.

ZAB0103

Metode optionale de incarcare:

Incarcator:

Conectati bateria in incarcator apoi introduceti incarcatorul la retea de alimentare

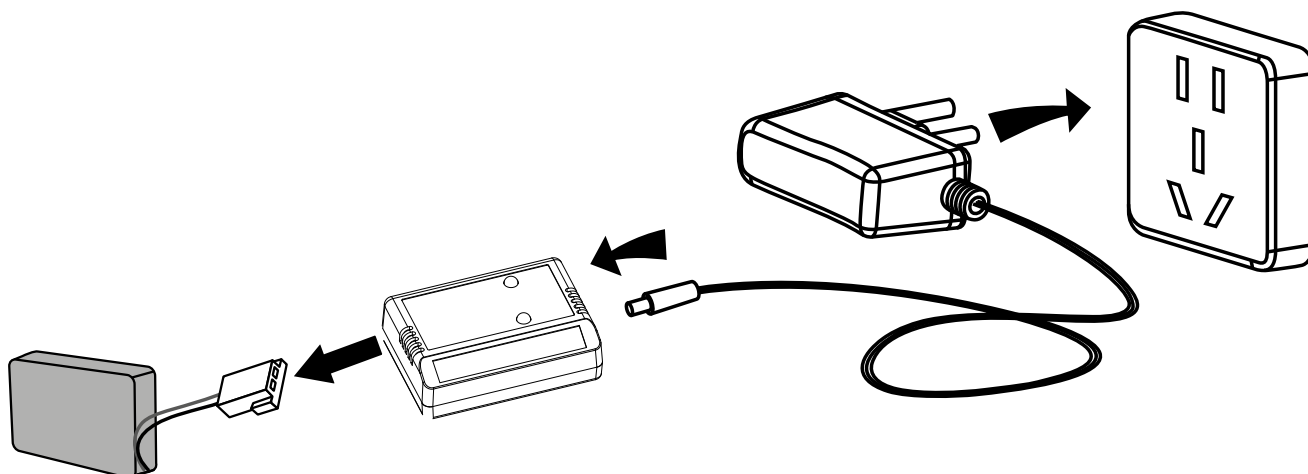

Incarcare USB:

Conectati cablul USB la baterie iar celalalt capat conectati-l la portul USB al unui calculator.



Utilizati doar accesoriile incluse in colet pentru incarcarea bateriei reincarcabile. Nu lasati bateria nesupravegheata pe durata incarcarii.

Dupa montarea bateriei incarcate in drona, conectati conectorul rosu al bateriei la placa de baza. Drona este acum incarcata si gata de zbor.

Timp aproximativ de incarcare:

ZAB0101: 120 min (de la portul USB) / 90 min (de la incarcatorul AC)

ZAB0103: 150 min (de la portul USB) / 120 min (de la incarcatorul AC)

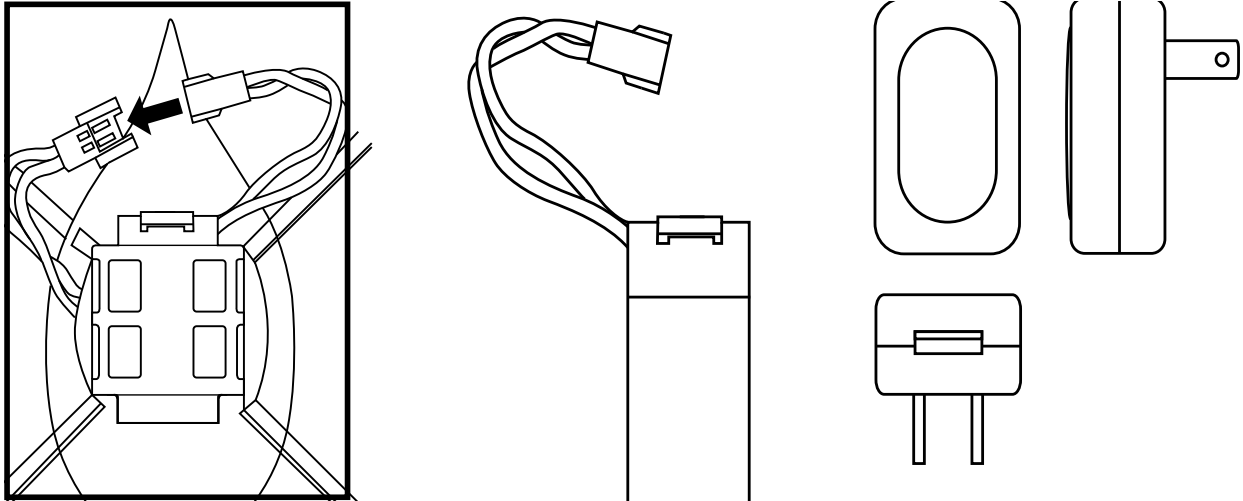

Retineti ca acesti timpi sunt doar ca referinta, timpul de incarcare este doar o estimare si poate depinde de model si de diversi parametri.

CONTROLLER (TELECOMANDA)

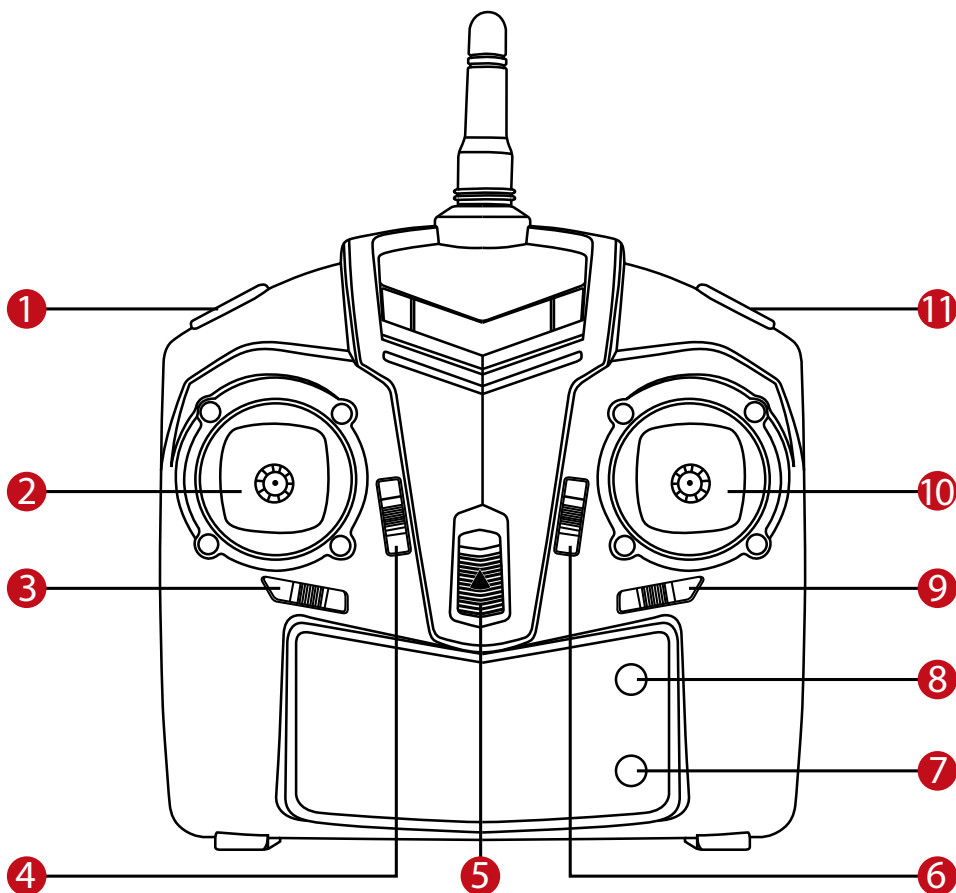

1. Selectare viteza / Auto trim / Mod Compass (ZAB0103)

Selectare viteza / Functia Auto trim

Apasati butonul de selectare a vitezei pentru a alege intre diferite optiuni de viteza.

Viteza redusa, un beep.

Viteza medie, doua beep-uri.

Viteza mare, trei beep-uri.

To auto-trim, turn on the controller while pushing in the Auto-Trim button.

2. Joystick stanga
3. Cursor inclinare B
4. Cursor inclinare A
5. Comutator alimentare
6. Cursor inclinare D
7. Inregistrare video
8. Efectuare fotografie
9. Cursor inclinare C
10. Joystick dreapta
11. LED on/off / Comutator control mod

LED on/off, Comutator control mod :

Apasati odata iar LED-urile se aprind.

Apasati si tineti apasat pana cand se aude un beep pentru comutarea intre diverse moduri de control.

OPERARE

1. Pozitionati maneta de acceleratie in jos

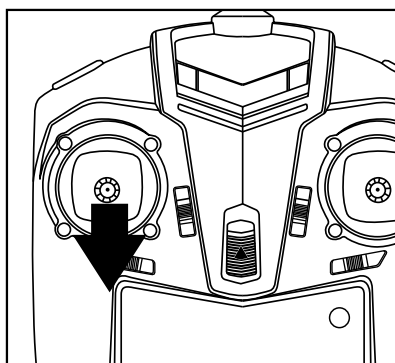

2. Porniti telecomanda

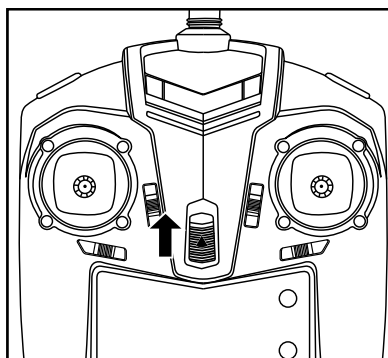

3. Introduceți bateriile în telecomandă respectând polaritatea corectă și conectați bateriile la conector. (LED-ul dronei va palpa rapid)

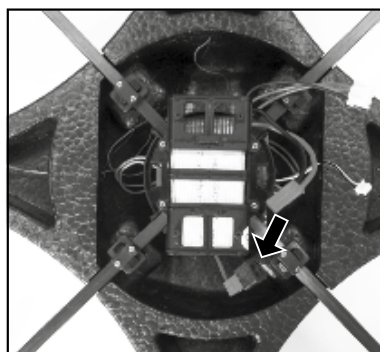

4. Amplasați drona pe o suprafață orizontală.

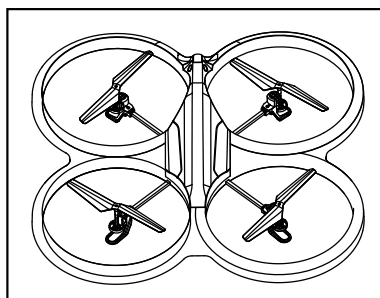

5. Manevrați maneta de accelerație în sus și în jos, veți auzi un sunet. Telecomandă se conectează la drona (LED-ul dronei rămâne aprins). Drona este gata de zbor!

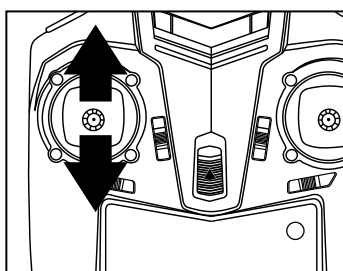

MOD 1

Operare si control

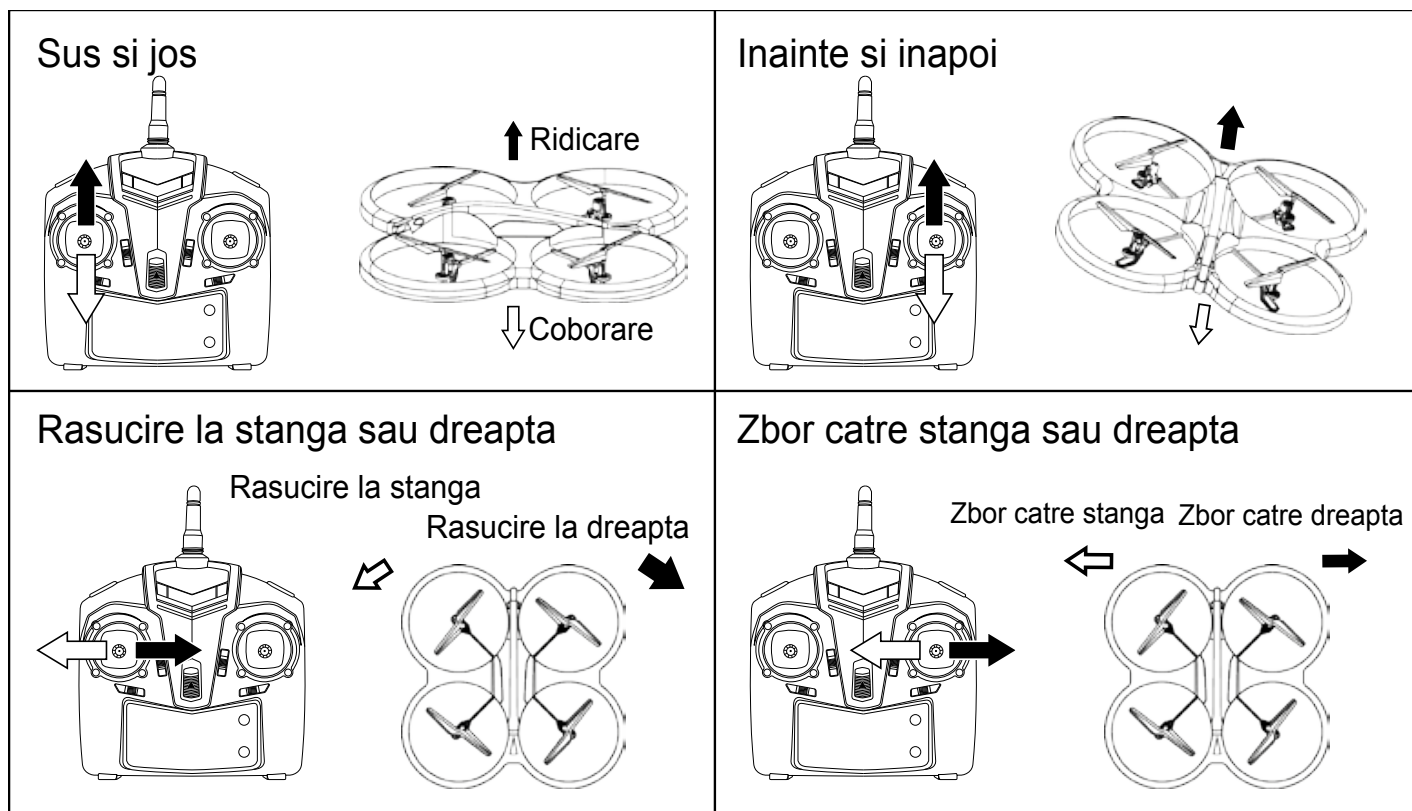

Atentie: Cand drona zboara catre dvs., directiile de control sunt inversate.

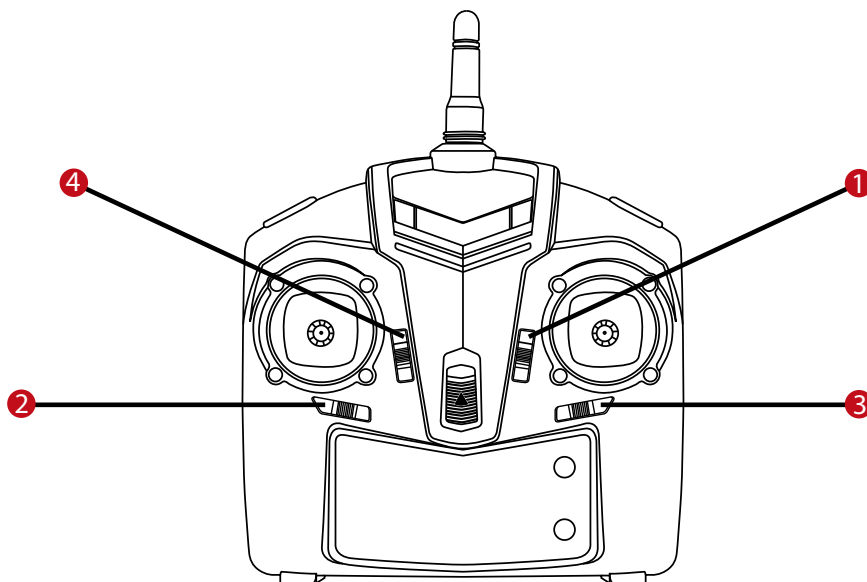

Reglare fina inclinare

1. Reglare fina inclinare fata-spate
2. Reglare fina rotire stanga/dreapta
3. Reglare fina deplasare stanga/dreapta
4. Reglare fina deplasare sus/jos

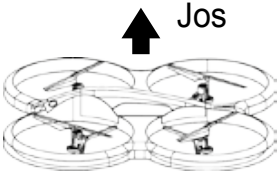
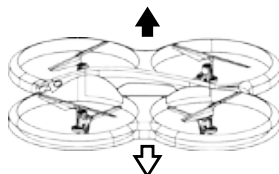
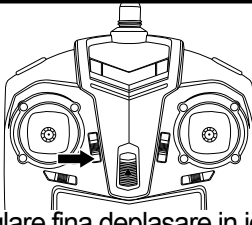
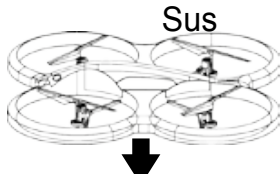
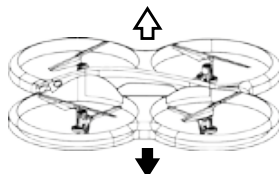
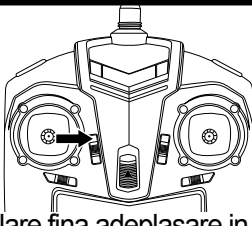
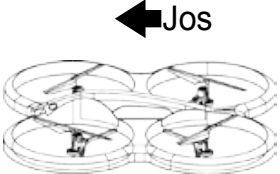
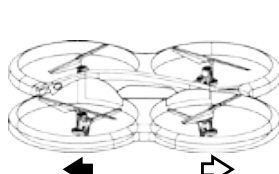
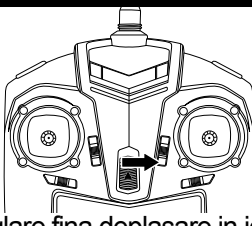
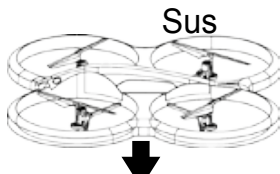
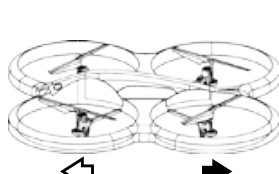
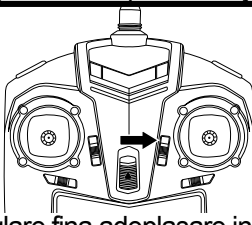
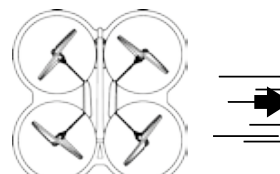
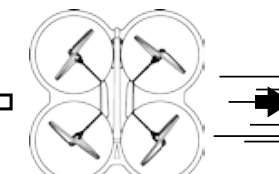
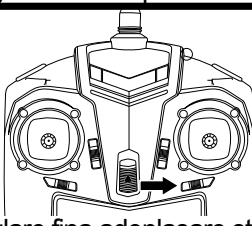
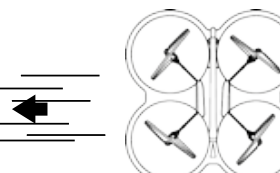
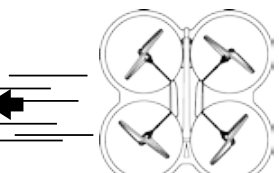
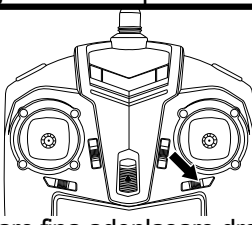
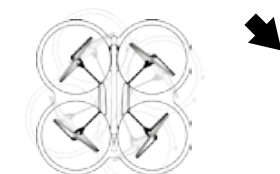
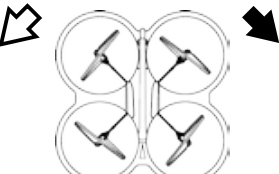
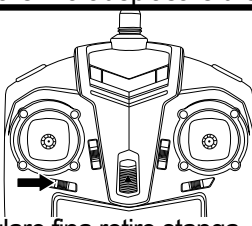
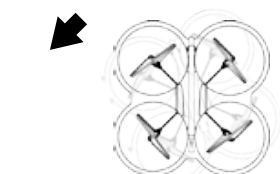
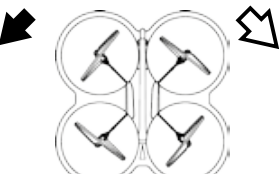
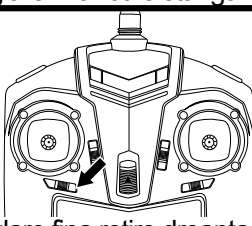
<p>Control deplasare in jos</p>			 <p>Reglare fina deplasare in jos</p>
<p>Control deplasare in sus</p>			 <p>Reglare fina adeplasare in sus</p>
<p>Control deplasare in jos</p>			 <p>Reglare fina deplasare in jos</p>
<p>Control deplasare in sus</p>			 <p>Reglare fina adeplasare in sus</p>
<p>Control deplasare stanga</p>			 <p>Reglare fina adeplasare stanga</p>
<p>Control deplasare dreapta</p>			 <p>Reglare fina adeplasare dreapta</p>
<p>Control rotire stanga</p>			 <p>Reglare fina rotire stanga</p>
<p>Control rotire dreapta</p>			 <p>Reglare fina rotire dreapta</p>

Rotiri

Puteti executa acrobatii numai cand drona se afla in modul viteza mare. Apasati butonul de control viteza pentru a intra in modul de viteza mare si apoi controlati din joystick (carma) pentru a efectua o rotire.

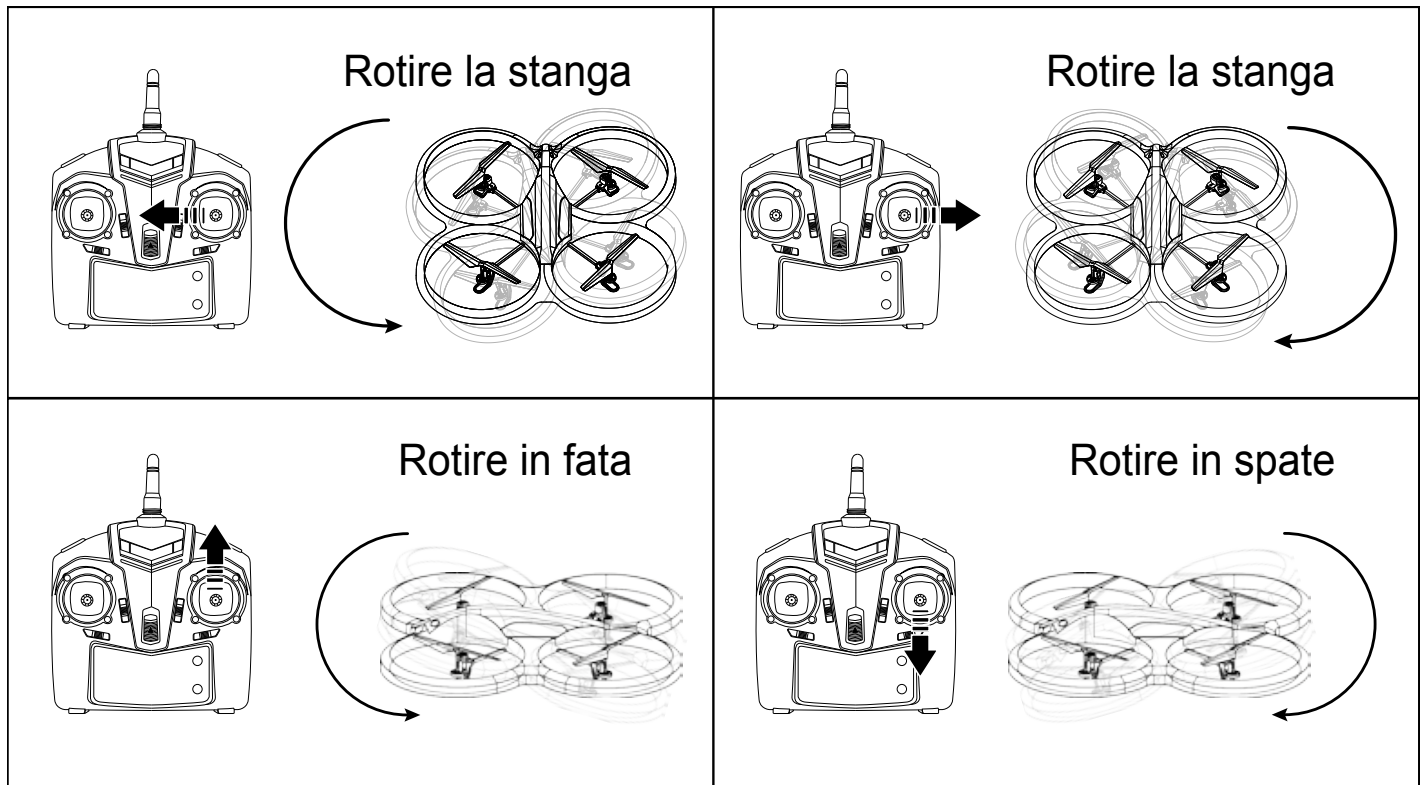

ATENTIE: Inainte de a efectua acrobatii, verificati sa aveti spatiu suficient in toate directiile pentru aceste manevre.

MOD 2

Operare si control

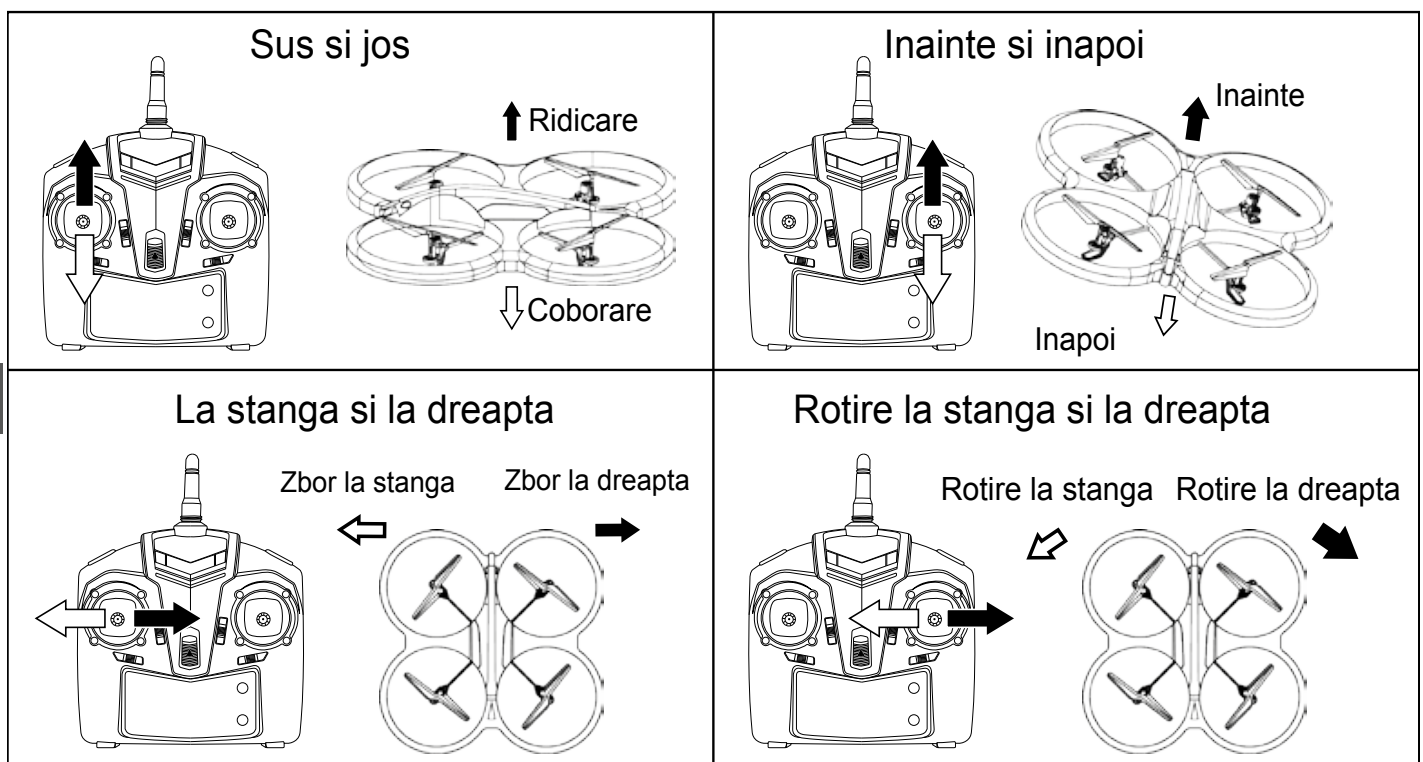



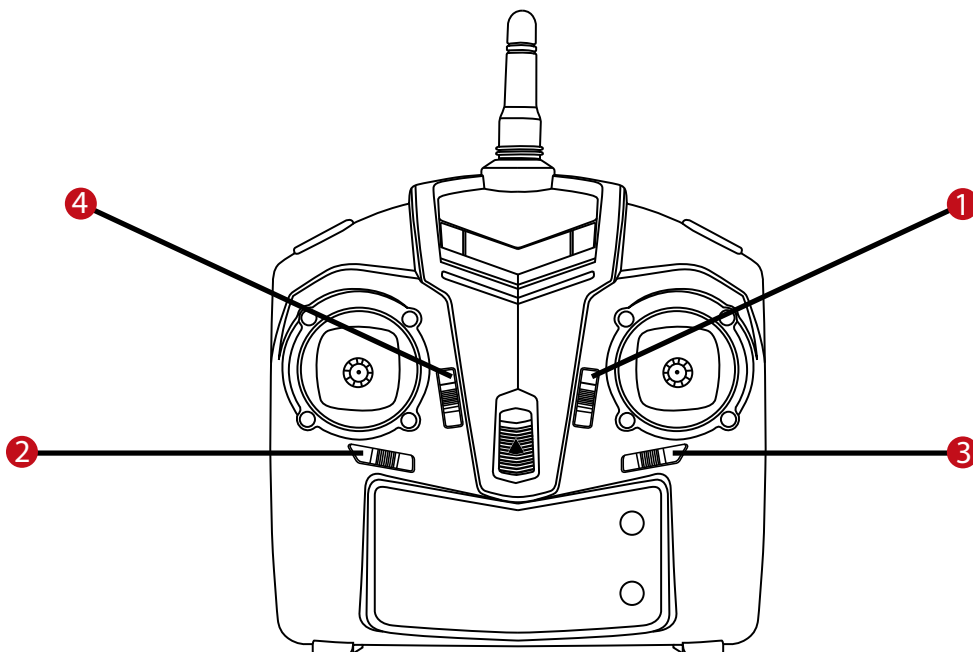

Atentie: Cand drona zboara catre dvs., directiile de control sunt inversate

Reglare fina inclinare

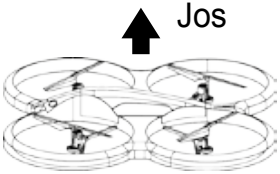
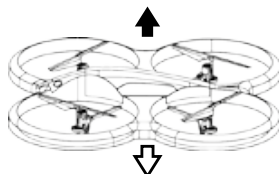
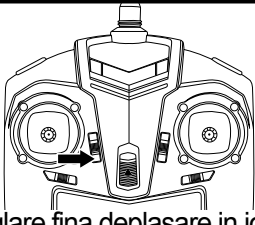
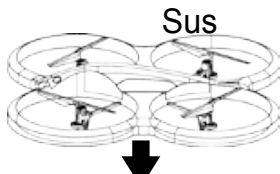
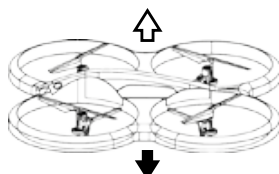
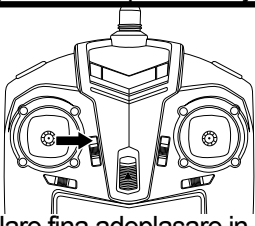
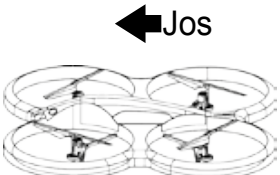
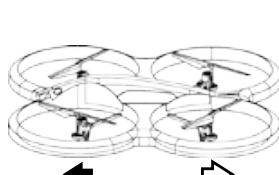
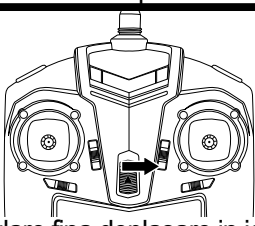
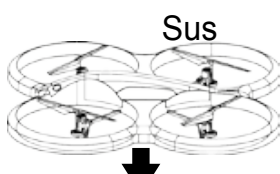
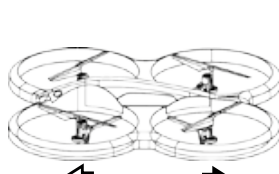
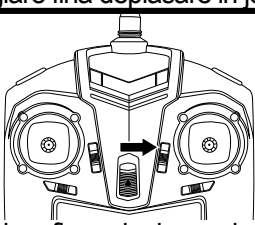
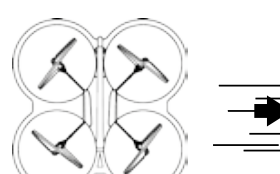
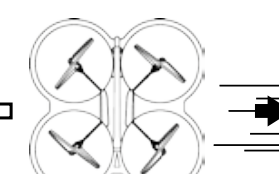
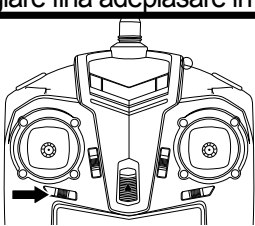
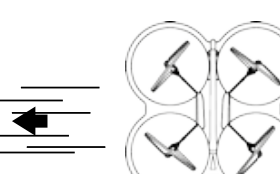
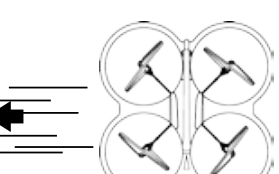
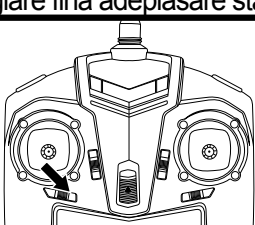
1. Reglare fina inclinare fata-spate
2. Reglare fina rotire stanga/dreapta
3. Reglare fina deplasare stanga/dreapta
4. Reglare fina deplasare sus/jos

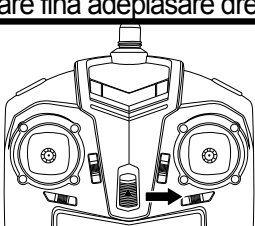

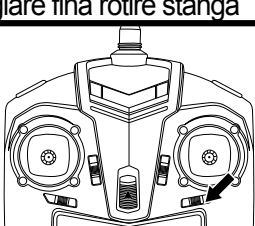
<p>Control deplasare in jos</p>			 <p>Reglare fina deplasare in jos</p>
<p>Control deplasare in sus</p>			 <p>Reglare fina adeplasare in sus</p>
<p>Control deplasare in jos</p>			 <p>Reglare fina deplasare in jos</p>
<p>Control deplasare in sus</p>			 <p>Reglare fina adeplasare in sus</p>
<p>Control deplasare stanga</p>			 <p>Reglare fina adeplasare stanga</p>
<p>Control deplasare dreapta</p>			 <p>Reglare fina adeplasare dreapta</p>
<p>Control rotire stanga</p>			 <p>Reglare fina rotire stanga</p>
<p>Control rotire dreapta</p>			 <p>Reglare fina rotire dreapta</p>

RO

Rotiri

Puteti executa acrobatii numai cand drona se afla in modul viteza mare. Apasati butonul de control viteza pentru a intra in modul de viteza mare si apoi controlati din joystick (carma) pentru a efectua o rotire.

ATENTIE: Inainte de a efectua acrobatii, verificati sa aveti spatiu suficient in toate directiile pentru aceste manevre.

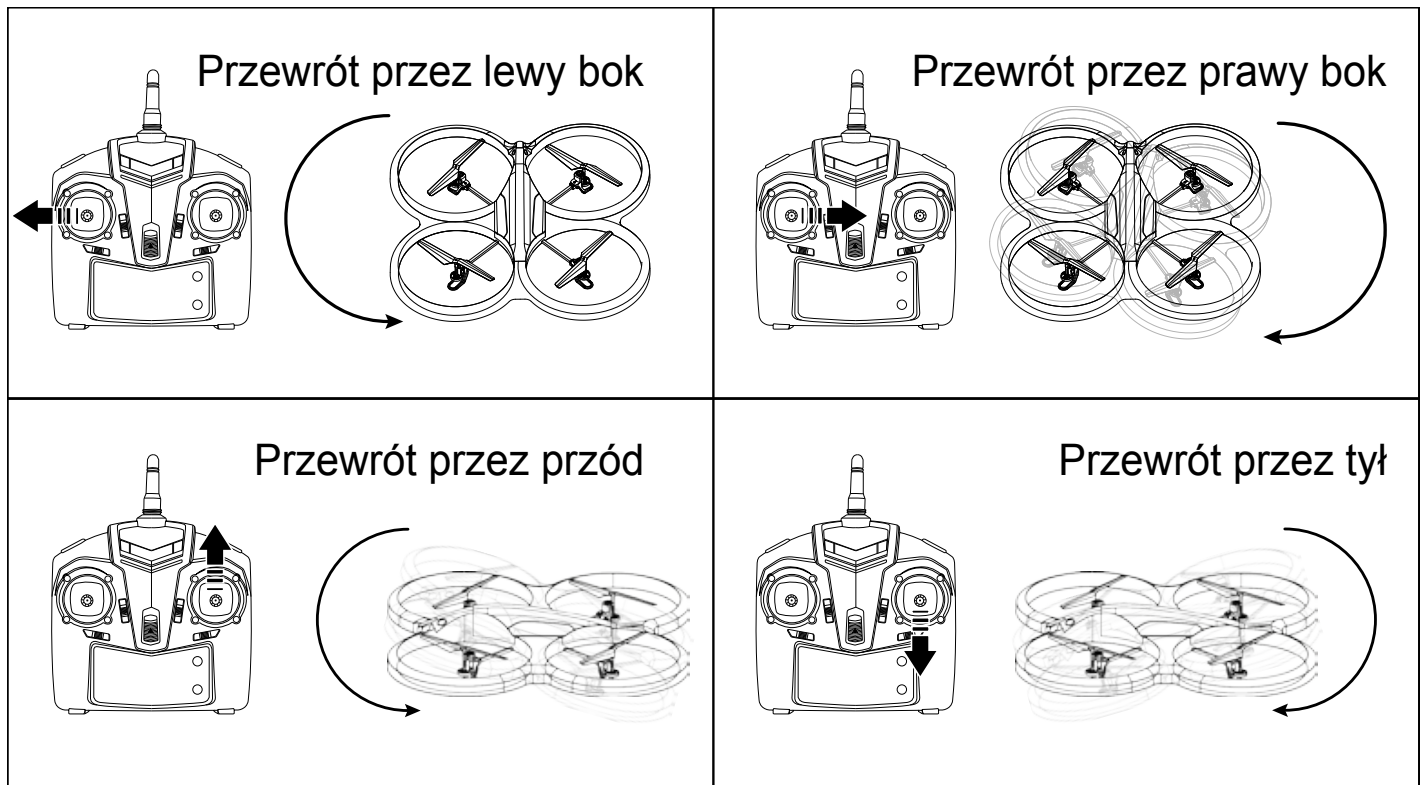

Funcția auto-reglare (Mod 1/Mod 2)

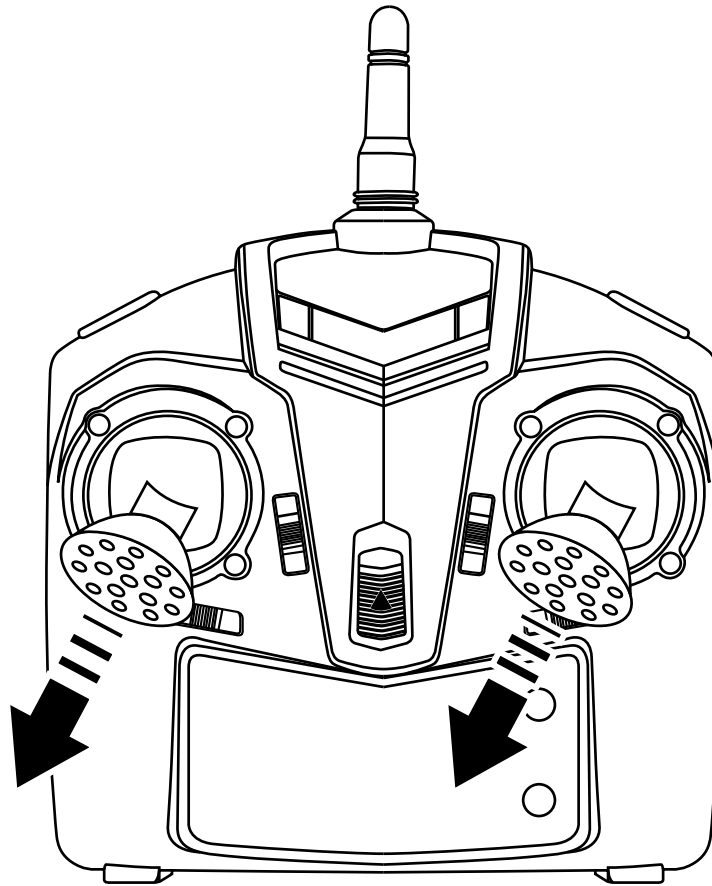

1. Apasati butonul „SPEED” pentru a intra in modul de viteza mare (3 beep-uri) (inainte de aceasta operatie asezati drona pe o suprafata orizontala)
2. Apasati ambele manete (acceleratie si carma) la 45 grade timp de 10 secunde (asa cum se arata in figura de mai jos), veti vedea lumina de pe drona palpaing rapid, lumina de pe telecomanda ramane aprinsa iar cand eliberati manetele, lumina de pe drona ramane aprinsa ceea ce inseamna ca s-a efectuat autoreglarea.

Inlocuire elice

Aparatul este livrat cu 4 elice de schimb; 2 tip (A) si 2 tip (B) - veti vedea tipul marcat pe elice.

Cand inlocuiti elicele deteriorate, aveti grija sa le montati in pozitia corespunzatoare.

Funcția headless (Mod compass)

CUM SE INTRA/IESE DIN ACEASTA FUNCTIE?

Apasati butonul de pe telecomanda pentru 3 secunde (asa cum se vede in figura de ami jos) pana cand se aude un beep, si aparatul intra in modul compass. Pentru a iesi din acest mod, apasati inca o data pe acelasi buton timp de 3 secunde, pana cand sunetul dispare.

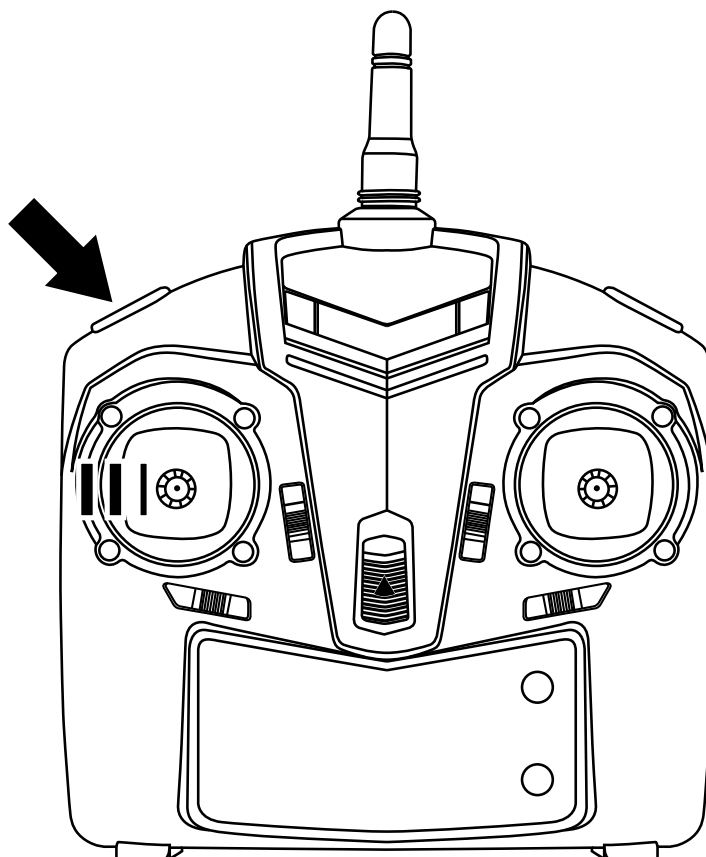

Modul “headless” faciliteaza controlul dispozitivului, asigurand functionarea precisa indiferent de pozitia dronei si a pilotului.

Nu trebuie sa fiti atenti unde este partea din fata a dronei la un moment dat.

Indiferent de pozitia dronei si a pilotului, dispozitivul va raspunde intotdeauna in mod corespunzator si va zbura in directia indicata de telecomanda.

LISTA COMPONENTE

ZAB0101

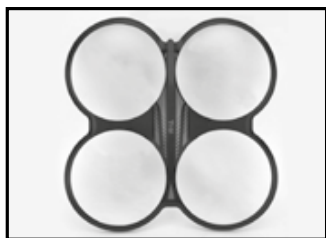

Protectie elice



Carcasa motor



Fibra de carbon



Baza motor

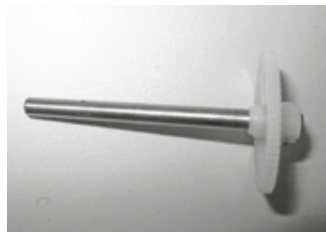

Set roti



Baza baterie



Elice

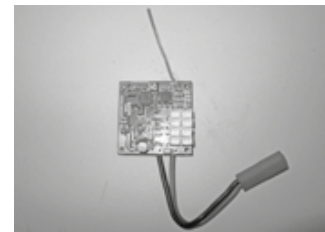

Placa receptor



Baterie Li-Polimer

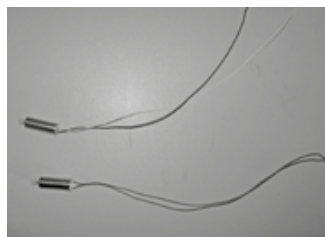

Motor

ZAB0103



Protectie elice



Baza motor



Carcasa motor

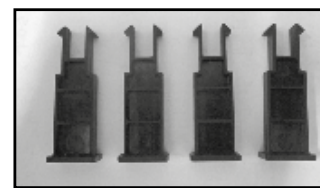

Element fixare protectie (A)



PCB

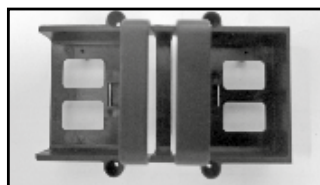

Locas baterie

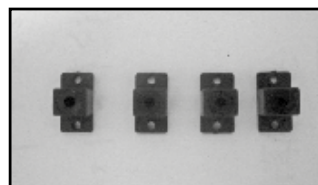

Element fixare protectie (B)



Element fixare protectie (C)

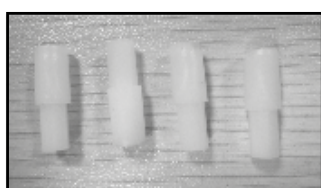

Element fixare elice



Roata

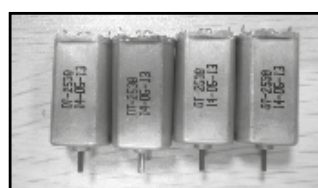

Motor



Baterie

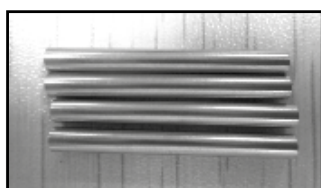

Tub metalic

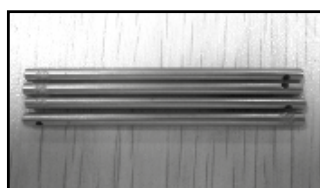

Ax principal

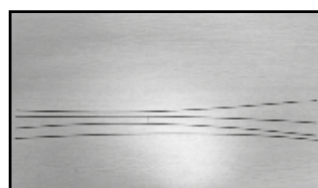

Fibra de carbon pentru protectie

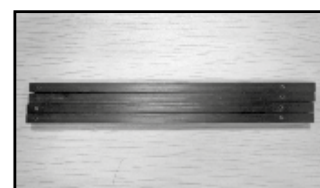

Fibra de carbon



Cablul motor (rosu/albastru)



Cablul motor (negru/rosu)



Cablul LED pentru protectie

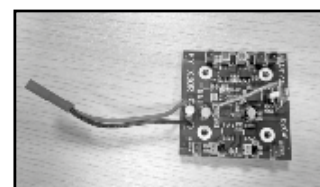

Placa receptor



Suruburi



Kit aterizare

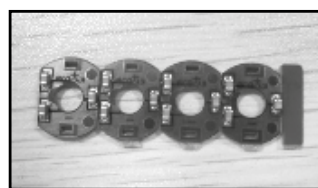

PCB motor



Rotita metalica pentru motor



Elice

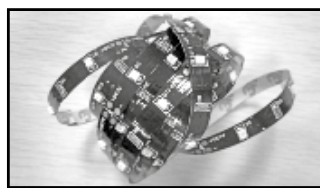

Banda LED

RO

Specificatiile sunt supuse schimbarilor fara notificare prealabila.

„Compania Lechpol declară că produsul ZAB0101/ZAB0103 este în conformitate cu cerințele esențiale și alte prevederi relevante ale Directivei 1999/5/CE. Declarația pentru descărcare este postata pe site-ul www.lechpol.eu”



Romania
Reciclarea corecta a acestui produs
(reziduuri provenind din aparatura electrica si electronica)



RO

Marcajale de pe acest produs sau mentionate in instructiunile sale de folosire indica faptul ca produsul nu trebuie aruncat impreuna cu alte reziduuri din gospod arie atunci cand nu mai este in stare de functionare. Pentru a preveni posibile efecte daunatoare asupra mediului inconjurator sau a san ata tii oamenilor datorate evacuarii necontrolate a reziduurilor, vă rugăm să separați acest produs de alte tipuri de reziduuri si să-l reciclati in mod responsabil pentru a promova re folosirea resurselor materiale. Utilizatorii casnici sunt rugati să ia legatura fie cu distribuitorul de la care au achizitionat acest produs, fie cu autoritatile locale, pentru a primi informatii cu privire la locul si modul in care pot depozita acest produs in vederea reciclarii sale ecologice. Utilizatorii instititionali sunt rugati să ia legatura cu furnizorul și să verifice condițiile stipulate in contractul de vanzare. Acest produs nu trebuie amestecat cu alte reziduuri de natura comerciala.

Distribuit de Lechpol Electronics SRL, Republicii nr. 5, Resita, CS, ROMANIA